



**Selection Guide  
for NSB & N1  
Non-Communicating  
Sensors**



# Overview

Automated Logic (ALC) has been developing and supporting intelligent building solutions that have helped customers operate their buildings more efficiently for over 45 years. We take pride in being a global leader in building automation systems and working with customers ranging from small, family-owned businesses to Fortune 500 corporations.

ALC's comprehensive NSB and N1 portfolio of non-communicating sensors consists of temperature, humidity, pressure, and air quality sensors as well as an assortment of sensor accessories. Designed to work seamlessly with the WebCTRL® building automation system, these sensors come in a variety of configuration options to meet your project needs. They can be ordered directly through Automated Logic's online store.



# Table of Contents

## Temperature Sensors

Duct Temperature Sensors and Transmitters .....	6-7
Flexible Duct Averaging Temperature Sensor and Transmitters .....	8-9
Rigid Duct Averaging Temperature Sensors .....	10
Outside Air Temperature Sensors .....	11
Immersion Temperature Sensors and Transmitters without Thermowells .....	12-13
Immersion Temperature Sensors and Transmitters with Thermowells .....	14-15
Thermowells for Immersion Sensors .....	16
Immersion Temperature Sensors with Stainless Steel Threads .....	17
Remote Probe and Concave Probe Temperature Sensors without Enclosure .....	18
Remote Probe and Concave Probe Temperature Sensors with Enclosure .....	19
Strap and Clamp-On and Temperature Sensors .....	20
Thermobuffer Temperature Sensor for Freezers and Coolers .....	21
Submersible Duct Temperature Sensors .....	22
Analog ZS2 Room Temperature Sensors .....	22
Delta Style Enclosure Room Temperature Sensors .....	23
Low Profile "Button" Temperature Sensors .....	23
Wall Plate Temperature Sensors .....	23

## Temperature and Humidity Sensors

Duct Humidity or Temp/Humidity Sensors .....	26
Outside Air Humidity or Temp/Humidity Sensors .....	27
Delta Style Enclosure Room Humidity or Temp/Humidity Sensors .....	28

## Differential Air Pressure Sensors, Switches and Accessories

ZPM BB (IP66) Differential Air Pressure Sensor .....	32
ZPM (IP44) Differential Air Pressure Sensor .....	32
EZ Panel Mount Differential Air Pressure Sensor .....	32
Pressure Switch in a BB Enclosure .....	33
Beck Pressure Switch .....	33
Pressure Pickup Ports .....	34
Pressure Probes .....	35

## Air Quality Sensors

Carbon Dioxide (CO <sub>2</sub> ) Room Sensors .....	38
Carbon Dioxide (CO <sub>2</sub> ) Duct Sensors .....	38
Volatile Organic Compound (VOC) Duct Sensors .....	39
Carbon Monoxide (CO) Programmable Duct and Rough Service Sensors .....	40
Carbon Monoxide (CO) Rough Service Sensors .....	40
Replacement Carbon Monoxide (CO) Sensors Module .....	40
Nitrogen Dioxide (NO <sub>2</sub> ) Programmable Duct and Rough Service Sensors .....	41
Replacement Nitrogen Dioxide (NO <sub>2</sub> ) Sensor Module .....	41
Particulate Matter Room and Duct Sensors .....	42
Refrigerant Leak Detectors .....	43

## Accessories for HVAC/R

Water Leak Detectors .....	46
Voltage Converters (350mA) .....	47
Thermostat Guards .....	47
Adaptor Plates for Retrofits .....	48
Foamback Insulator for Room Units .....	49
Flexible Probe Brackets .....	49
Pierceable Knockout Plugs for Open Enclosure Ports .....	49
Weather Shade Kits .....	50
Light Level Sensors .....	50
Output Terminal Boards - OUT64A, OUT66, UIUO4 .....	51
Output Relay Board - UO4R .....	51
Relay Pack for the ZN551 Controller .....	51
Blü-Test Wireless Test Instruments .....	52
Calibration Certificates for Temperature and Humidity .....	53

## Enclosure Information

Non-Room Enclosure Specifications and Dimensions .....	56-57
--	-------

# Temperature Sensors



# Temperature Sensors



**Duct Temperature**  
pgs. 6-7



**Flexible Duct Averaging**  
pgs. 8-9



**Rigid Duct Averaging**  
pg. 10

**Outside Air Sensors**  
pg. 11

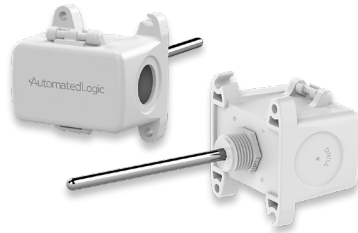

**Immersion Sensors**  
pgs. 12-15



**Thermowells**  
pg. 16



**Immersion with SS Threads**  
pg. 17

**Remote Probes**  
pgs. 18-19

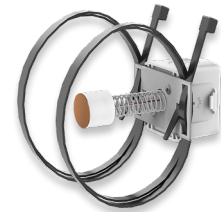

**Strap & Clamp Sensors**  
pg. 20

**Thermobuffer Sensors**  
pg. 21

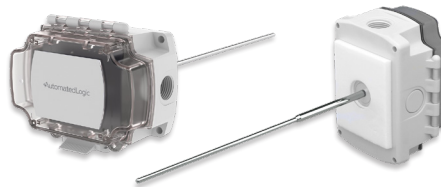

**Submersible Duct**  
pg. 22

**Analog ZS2 Sensors**  
pg. 23



**Delta Style Sensors**  
pg. 23



**Low Profile "Button" Sensors**  
pg. 23



**Wall Plate Sensors**  
pg. 23



# Duct Temperature Sensors

- 2 to 18" (50 to 450mm) Probe Lengths
- 10K-2 Thermistor Temperature Sensor
- Stainless Steel Duct Probe, 1/4" (6.3mm) Dia.
- 6 Enclosure Styles  
(see pgs 42-43 for enclosure info)

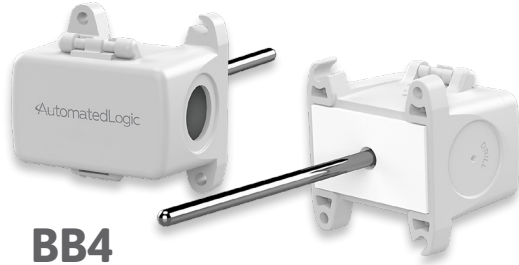

## BB4

Polycarbonate & Nylon BB4  
(IP10 or IP44 w/ knockout plug)

Part Number:	Probe Length:	
N1-10K-2-D-2-BB4-A	2"	50mm
NSB-10K-2-D-4-BB4-A	4"	100mm
NSB-10K-2-D-8-BB4-A	8"	200mm
NSB-10K-2-D-12-BB4-A	12"	300mm
NSB-10K-2-D-18-BB4-A	18"	450mm

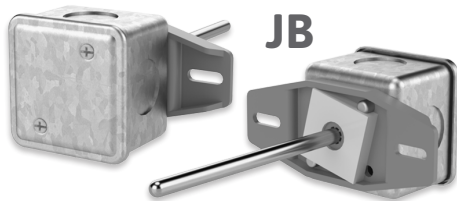

## JB

Galvanized Steel JB (IP20, NEMA 1)

Part Number:	Probe Length:	
NSB-10K-2-D-4-A	4"	100mm
NSB-10K-2-D-8-A	8"	200mm
NSB-10K-2-D-12-A	12"	300mm
NSB-10K-2-D-18-A	18"	450mm

50K Thermistor instead of 10K-2 below

NSB-50K-D-4-A	4"	100mm
---------------	----	-------

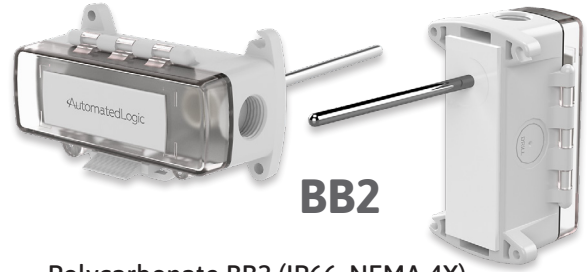

## BB2

Polycarbonate BB2 (IP66, NEMA 4X)

Part Number:	Probe Length:	
NSB-10K-2-D-4-BB2-A	4"	100mm
NSB-10K-2-D-8-BB2-A	8"	200mm
NSB-10K-2-D-12-BB2-A	12"	300mm
NSB-10K-2-D-18-BB2-A	18"	450mm

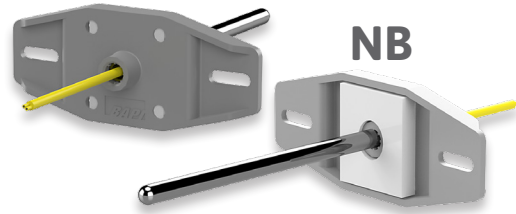

## NB

Nylon NB  
Mounting  
Bracket

Part Number:	Probe Length:		Lead Length:	
N1-10K-2-D-4-NB-18-A	4"	100mm	18"	450mm
NSB-10K-2-D-4-NB-5-A	4"	100mm	5'	1.5m
NSB-10K-2-D-4-NB-10-A	4"	100mm	10'	3m
NSB-10K-2-D-4-NB-15-A	4"	100mm	15'	4.5m
N1-10K-2-D-8-NB-18-A	8"	200mm	18"	450mm
N1-10K-2-D-8-NB-5-A	8"	200mm	5'	1.5m
NSB-10K-2-D-8-NB-10-A	8"	200mm	10'	3m
N1-10K-2-D-8-NB-15-A	8"	200mm	15'	4.5m
N1-10K-2-D-12-NB-5-A	12"	300mm	5'	1.5m
NSB-10K-2-D-12-NB-10-A	12"	300mm	10'	3m
NSB-10K-2-D-18-NB-10-A	18"	450mm	10'	3m



continued...

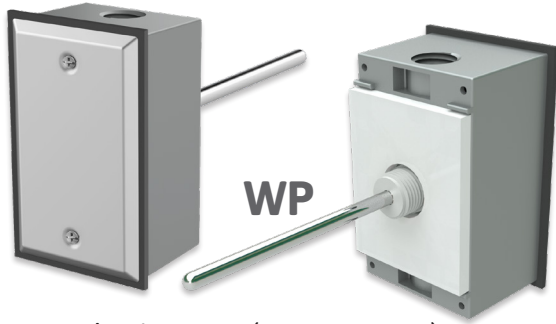

Cast Aluminum WP (IP24, NEMA 3R)

Part Number:	Probe Length:	
N1-10K-2-D-8-WP-A	8"	200mm
N1-10K-2-D-12-WP-A	12"	300mm
N1-10K-2-D-18-WP-A	18"	450mm

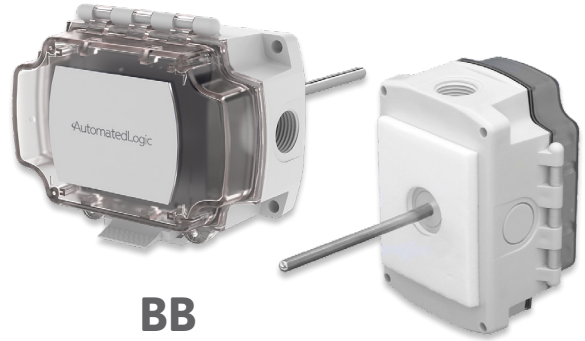

Polycarbonate BB (IP66, NEMA 4X)

Part Number:	Probe Length:	
N1-10K-2-D-4-BB-A	4"	100mm
N1-10K-2-D-8-BB-A	8"	200mm
N1-10K-2-D-12-BB-A	12"	300mm
N1-10K-2-D-18-BB-A	18"	450mm

## Duct Temperature Transmitters

- 4 to 12" (100 to 300mm) Probe Lengths
- 4 to 20mA Transmitted Output
- 20 to 120°F or -30 to 130°F Temperature Range
- Stainless Steel Duct Probe, 1/4" (6.3mm) Dia
- BB2 Enclosure Style  
(see pgs 42-43 for enclosure info)

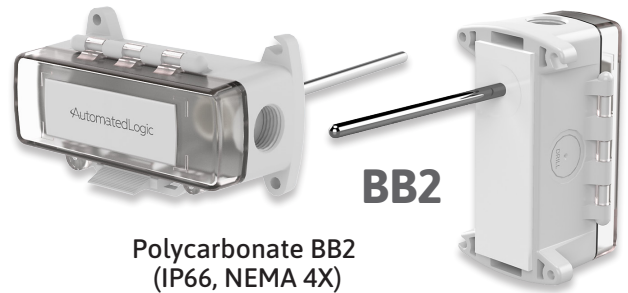

Polycarbonate BB2 (IP66, NEMA 4X)

Part Number:	Probe Length:		Temperature Range:
N1-T1K[20 TO 120F]-D-4-BB2-A	4"	100mm	20 to 120°F
N1-T1K[20 TO 120F]-D-8-BB2-A	8"	200mm	20 to 120°F
N1-T1K[20 TO 120F]-D-12-BB2-A	12"	300mm	20 to 120°F
N1-T1K[-30 TO 130F]-D-4-BB2-A	4"	100mm	-30 to 130°F
N1-T1K[-30 TO 130F]-D-8-BB2-A	8"	200mm	-30 to 130°F
N1-T1K[-30 TO 130F]-D-12-BB2-A	12"	300mm	-30 to 130°F

# Flexible Duct Averaging Temperature Sensors

- 8 to 50' (2.4 to 15m) Probe Lengths
- 10K-2 Thermistor Temperature Sensor
- Bendable Aluminum Probe, 3/16" (4.8mm) Dia.
- 5 Enclosure Styles  
(see pgs 42-43 for enclosure info)



**BB4**

Polycarbonate & Nylon BB4  
(IP10 or IP44 w/ knockout plug)

Part Number:	Probe Length:	
NSB-10K-2-A-8-BB4-A	8'	2.4m
NSB-10K-2-A-12-BB4-A	12'	3.7m
NSB-10K-2-A-24-BB4-A	24'	7.3m



**BB2**

Polycarbonate BB2  
(IP66, NEMA 4X)

Part Number:	Probe Length:	
NSB-10K-2-A-8-BB2-A	8'	2.4m
NSB-10K-2-A-12-BB2-A	12'	3.7m
NSB-10K-2-A-24-BB2-A	24'	7.3m
N1-10K-2-A-50-BB2-A	50'	15m



**JB**

Galvanized Steel JB (IP20, NEMA 1)

Part Number:	Probe Length:	
NSB-10K-2-A-8-A	8'	2.4m
NSB-10K-2-A-12-A	12'	3.7m
NSB-10K-2-A-24-A	24'	7.3m
N1-10K-2-A-50-A	50'	15m



**NB**

Nylon NB  
Mounting Bracket

Part Number:	Probe Length:	
N1-10K-2-A-8-NB-A	8'	2.4m
N1-10K-2-A-12-NB-A	12'	3.7m
N1-10K-2-A-24-NB-A	24'	7.3m



continued...

Part Number:	Probe Length:	
N1-10K-2-A-8-BB-A	8'	2.4m
N1-10K-2-A-12-BB-A	12'	3.7m
N1-10K-2-A-24-BB-A	24'	7.3m
N1-10K-2-A-50-BB-A	50'	15m

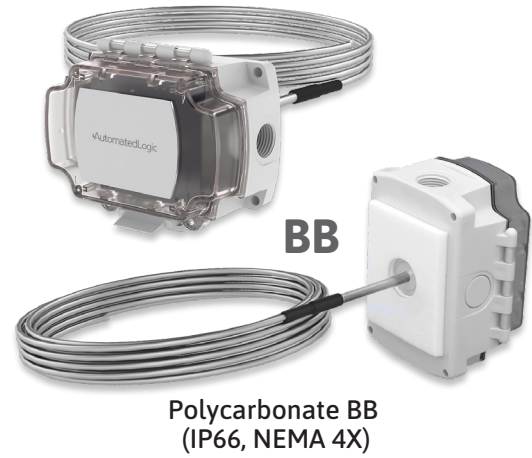

## Flexible Duct Averaging Temp Transmitters

- 8 to 50' (2.4 to 15m) Probe Lengths
- 4 to 20mA Transmitted Output
- Multiple Temperature Ranges
- Stainless Steel Duct Probe, 1/4" (6.3mm) Diameter
- BB or BB2 Enclosure Style  
(see pgs 42-43 for enclosure info)



Part Number:	Probe Length:		Temperature Range:
N1-T1K[20 TO 120F]-A-12-BB2-A	12'	3.7m	20 to 120°F
N1-T1K[20 TO 120F]-A-24-BB2-A	24'	7.3m	20 to 120°F
N1-T1K[20 TO 120F]-A-50-BB2-A	50'	15m	20 to 120°F
N1-T1K[-30 TO 130F]-A-8-BB2-A	8'	2.4m	-30 to 130°F
N1-T1K[-30 TO 130F]-A-12-BB2-A	12'	3.7m	-30 to 130°F
N1-T1K[-30 TO 130F]-A-24-BB2-A	24'	7.3m	-30 to 130°F
N1-T1K[32 TO 212F]-A-24-BB2-A	24'	7.3m	32 to 212°F

Part Number:	Probe Length:		Temp Range:
N1-T1K[-7 TO 49C]-A-24-BB-A	24'	7.3m	-7 to 49°C

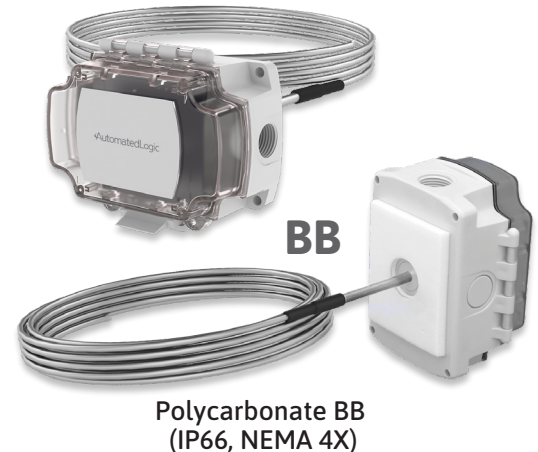

# Rigid Duct Averaging Temperature Sensors

- 12 to 48" (300mm to 1.2m) Probe Lengths
- 10K-2 Thermistor Temperature Sensor
- Stainless Steel Rigid Averaging Probe, 1/4" (6.3mm) Diameter
- 4 Enclosure Styles (see pgs 42-43 for enclosure info)

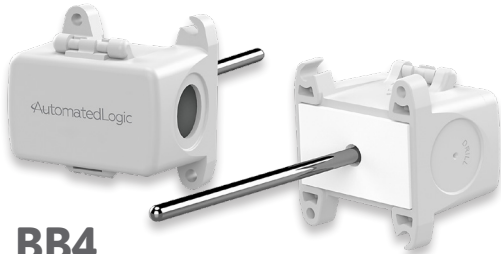

**BB4**

Polycarbonate & Nylon BB4  
(IP10 or IP44 w/ knockout plug)

Part Number:	Probe Length:	
NSB-10K-2-RA-12-BB4-A	12"	300mm
NSB-10K-2-RA-24-BB4-A	24"	600mm
NSB-10K-2-RA-36-BB4-A	36"	900mm
NSB-10K-2-RA-48-BB4-A	48"	1.2m

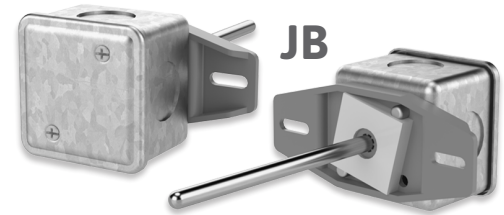

**JB**

Galvanized Steel JB (IP20, NEMA 1)

Part Number:	Probe Length:	
N1-10K-2-RA-24-A	24"	600mm
N1-10K-2-RA-36-A	36"	900mm
N1-10K-2-RA-48-A	48"	1.2m

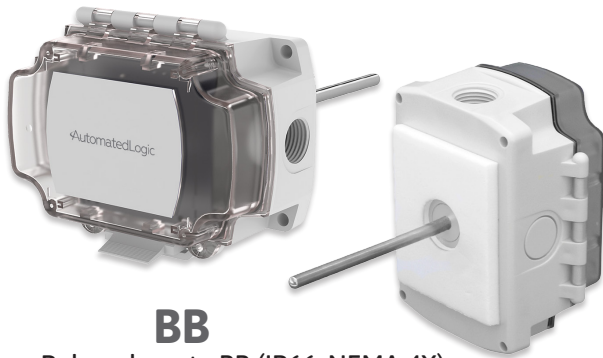

**BB**

Polycarbonate BB (IP66, NEMA 4X)

Part Number:	Probe Length:	
N1-10K-2-RA-12-BB-A	12"	300mm
N1-10K-2-RA-24-BB-A	24"	600mm
N1-10K-2-RA-36-BB-A	36"	900mm
N1-10K-2-RA-48-BB-A	48"	1.2m

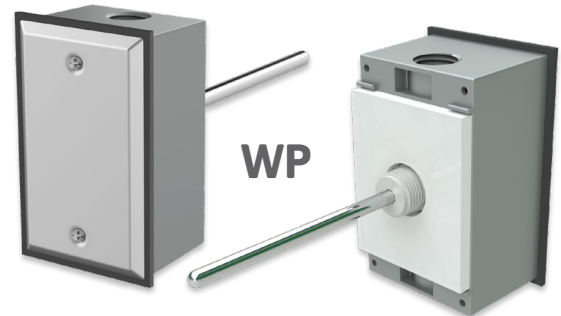

**WP**

Cast Aluminum WP (IP24, NEMA 3R)

Part Number:	Probe Length:	
N1-10K-2-RA-12-WP-A	12"	300mm
N1-10K-2-RA-24-WP-A	24"	600mm
N1-10K-2-RA-36-WP-A	36"	900mm
N1-10K-2-RA-48-WP-A	48"	1.2m



## Outside Air Temperature Sensors

- 10K-2 Thermistor Temperature Sensor
- 3 Enclosure Styles (see pgs 42-43 for enclosure info)



**BB2**

Polycarbonate BB2  
(IP66, NEMA 4X)

Part Number:

NSB-10K-2-O-BB2-A

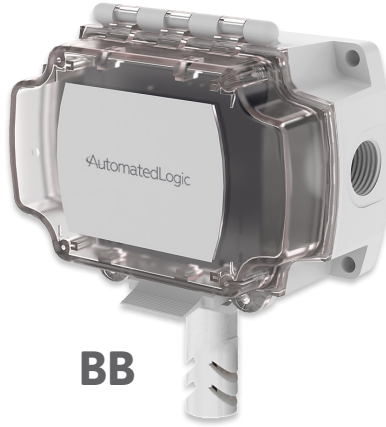

**BB**

Polycarbonate BB  
(IP66, NEMA 4X)

Part Number:

N1-10K-2-O-BB-A



**WP**

Cast Aluminum WP  
(IP24, NEMA 3R)

Part Number:

N1-10K-2-O-WP-A

## Outside Air Temperature Transmitters

- 4 to 20mA Transmitted Output
- Temperature Range: -20 to 120°F
- BB2 Enclosure Style (see pgs 42-43 for enclosure info)

Part Number:

N1-T1K[-20 TO 120F]-O-BB2-A

Temp. Range:

-20 to 120°F



**BB2**

Polycarbonate BB2  
(IP66, NEMA 4X)

# Immersion Temperature Sensors without Thermowells

- 10K-2 Thermistor Temperature Sensor
- Stainless Steel Duct Probe, 1/4" (6.3mm) Diameter
- Nylon Threads
- 5 Enclosure Styles (see pgs 42-43 for enclosure info)

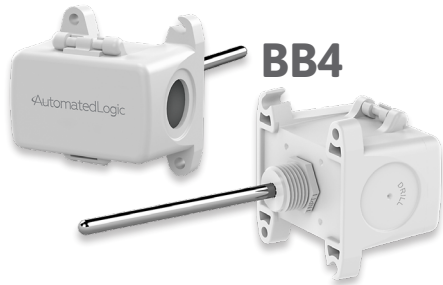

**BB4**

Polycarbonate & Nylon BB4  
(IP10 or IP44 w/ knockout plug)

Part Number:	Probe Length:	
NSB-10K-2-I-2-BB4-A	2"	50mm
NSB-10K-2-I-4-BB4-A	4"	100mm
NSB-10K-2-I-8-BB4-A	8"	200mm

Dual Thermistor unit below

N1-10K-2-I-4-BB4-DUAL-A	4"	100mm
-------------------------	----	-------

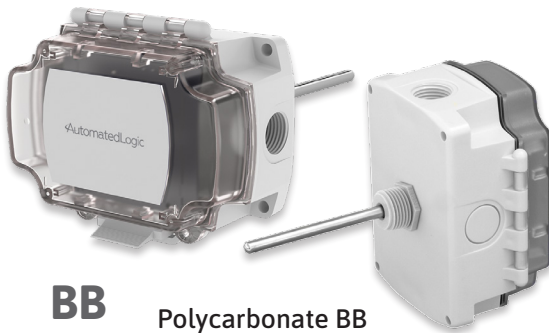

**BB**

Polycarbonate BB  
(IP66, NEMA 4X)

Part Number:	Probe Length:	
N1-10K-2-I-2-BB-A	2"	50mm
N1-10K-2-I-4-BB-A	4"	100mm
N1-10K-2-I-8-BB-A	8"	200mm



**BB2**

Polycarbonate BB2  
(IP66, NEMA 4X)

Part Number:	Probe Length:	
NSB-10K-2-I-2-BB2-A	2"	50mm
NSB-10K-2-I-4-BB2-A	4"	100mm
NSB-10K-2-I-8-BB2-A	8"	200mm

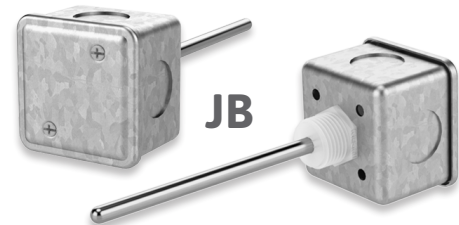

**JB**

Galvanized Steel JB (IP20, NEMA 1)

Part Number:	Probe Length:	
NSB-10K-2-I-2-A	2"	50mm
NSB-10K-2-I-4-A	4"	100mm
NSB-10K-2-I-8-A	8"	200mm

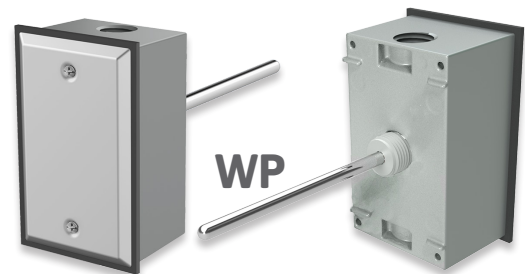

**WP**

Cast Aluminum WP (IP24, NEMA 3R)

Part Number:	Probe Length:	
N1-10K-2-I-2-WP-A	2"	50mm
N1-10K-2-I-4-WP-A	4"	100mm



## Immersion Temperature Transmitters without Thermowells

- 4 to 20mA Transmitted Output
- 0 to 100°F, 20 to 120°F or 32 to 212°F Temperature Range
- Stainless Steel Duct Probe, 1/4" (6.3mm) Diameter
- Nylon Threads
- 2 Enclosure Styles (see pgs 42-43 for enclosure info)

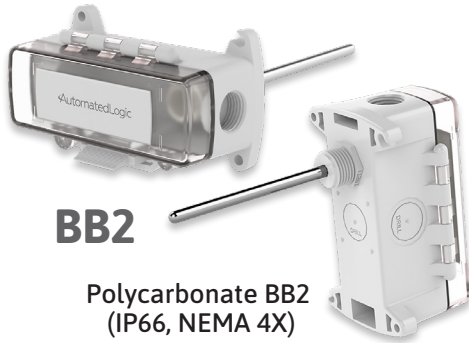

Part Number:	Probe Length:		Temp. Range:
N1-T1K[0 TO 100F]-I-2-BB2-A	2"	50mm	0 to 100°F
N1-T1K[0 TO 100F]-I-4-BB2-A	4"	100mm	0 to 100°F
N1-T1K[0 TO 100F]-I-8-BB2-A	8"	200mm	0 to 100°F
N1-T1K[20 TO 120F]-I-2-BB2-A	2"	50mm	20 to 120°F
N1-T1K[20 TO 120F]-I-4-BB2-A	4"	100mm	20 to 120°F
N1-T1K[32 TO 212F]-I-2-BB2-A	2"	50mm	32 to 212°F

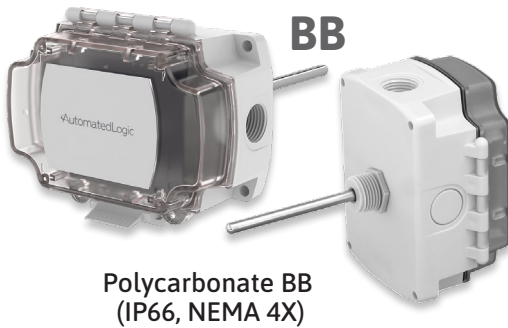

Part Number:	Probe Length:		Temp. Range:
N1-T1K[0 TO 100F]-I-4-BB-A	4"	100mm	0 to 100°F
N1-T1K[32 TO 212F]-I-8-BB-A	8"	200mm	32 to 212°F

## Immersion Extra Precision Temperature Sensors without Thermowells

- 10K-2 Extra Precision Thermistor
- Stainless Steel Duct Probe, 1/4" (6.3mm) Diameter
- Nylon Threads
- BB2 Enclosure Style (see pgs 42-43 for enclosure info)



Part Number:	Probe Length:	
N1-10K-2[XP]-I-2-BB2-A	2"	50mm
N1-10K-2[XP]-I-4-BB2-A	4"	100mm
N1-10K-2[XP]-I-8-BB2-A	8"	200mm

# Immersion Temperature Sensors with Thermowells

- 10K-2 Thermistor Temperature Sensor
- Stainless Steel Probe, 1/4" (6.3mm) Diameter
- Nylon Threads
- Included 304 Stainless Steel or Brass Thermowell
- 5 Enclosure Styles  
(see pgs 42-43 for enclosure info)

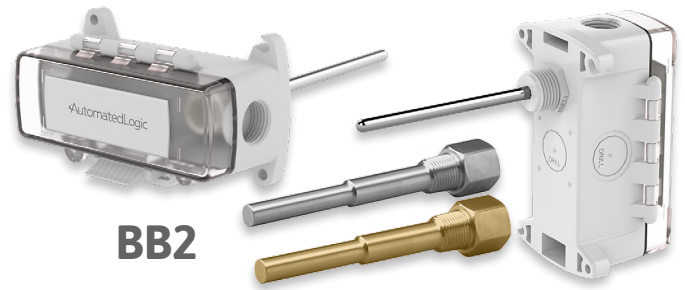

**BB2**

Polycarbonate BB2 (IP66, NEMA 4X)

Part Number:	Probe Length:		Thermo.
NSB-10K-2-I-2-BB2-M304-A	2"	50mm	304 SS
NSB-10K-2-I-4-BB2-M304-A	4"	100mm	304 SS
N1-10K-2-I-8-BB2-M304-A	8"	200mm	304 SS
N1-10K-2-I-2-BB2-MB-A	2"	50mm	Brass

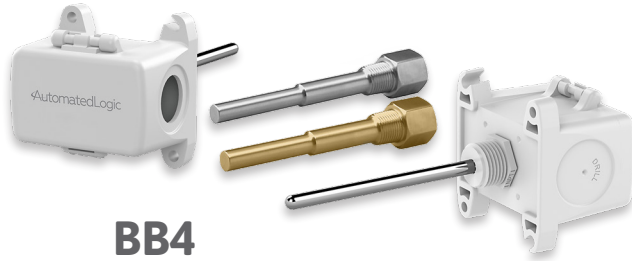

**BB4**

Polycarbonate & Nylon BB4 (IP10 or IP44 w/ knockout plug)

Part Number:	Probe Length:		Thermo.
N1-10K-2-I-2-BB4-M304-A	2"	50mm	304 SS
N1-10K-2-I-4-BB4-M304-A	4"	100mm	304 SS
N1-10K-2-I-8-BB4-M304-A	8"	200mm	304 SS
N1-10K-2-I-4-BB4-MB-A	4"	100mm	Brass



**JB**

Galvanized Steel JB (IP20, NEMA)

Part Number:	Probe Length:		Thermo.
NSB-10K-2-I-2-M304-A	2"	50mm	304 SS
NSB-10K-2-I-4-M304-A	4"	100mm	304 SS
NSB-10K-2-I-8-M304-A	8"	200mm	304 SS

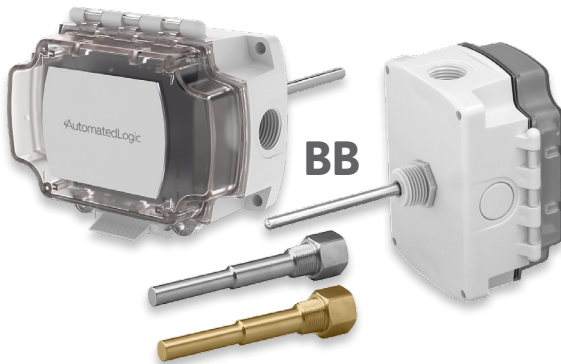

**BB**

Polycarbonate BB (IP66, NEMA 4X)

Part Number:	Probe Length:		Thermo.
N1-10K-2-I-2-BB-M304-A	2"	50mm	304 SS
N1-10K-2-I-4-BB-M304-A	4"	100mm	304 SS
N1-10K-2-I-8-BB-M304-A	8"	200mm	304 SS
N1-10K-2-I-2-BB-MB-A	2"	50mm	Brass

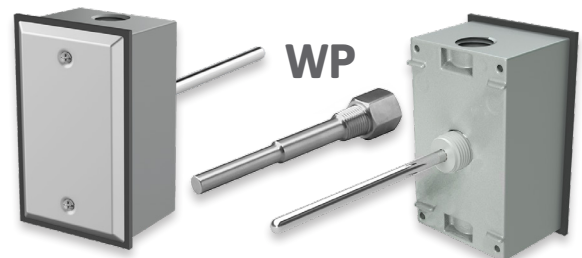

**WP**

Cast Aluminum WP (IP24, NEMA 3R)

Part Number:	Probe Length:		Thermo.
N1-10K-2-I-2-WP-M304-A	2"	50mm	304 SS
N1-10K-2-I-4-WP-M304-A	4"	100mm	304 SS
N1-10K-2-I-8-WP-M304-A	8"	200mm	304 SS

# Immersion Temperature Transmitters with Thermowells

- 4 to 20mA Transmitted Output
- 20 to 120°F or 32 to 212°F Temperature Range
- Stainless Steel Probe, 1/4" (6.3mm) Diameter
- Nylon Threads
- Included 304 Stainless Steel Thermowell
- 2 Enclosure Styles (see pgs 42-43 for info)

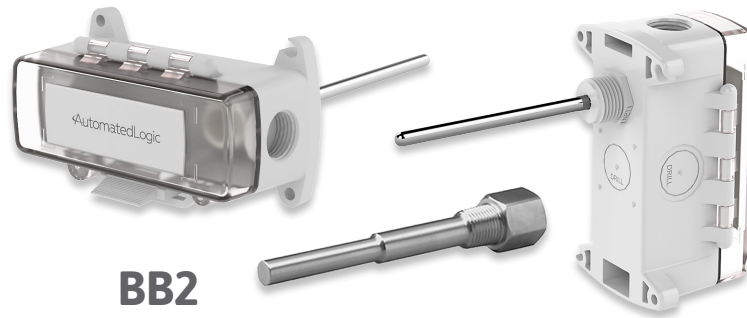

**BB2**

Polycarbonate BB2 (IP66, NEMA 4X)

Part Number:	Probe Length:		Temp. Range:
N1-T1K20-120F-I-2-BB2-M304-A	2"	50mm	20 to 120°F
N1-T1K20-120F-I-4-BB2-M304-A	4"	100mm	20 to 120°F
N1-T1K20-120F-I-8-BB2-M304-A	8"	200mm	20 to 120°F
N1-T1K32-212F-I-2-BB2-M304-A	2"	50mm	32 to 212°F
N1-T1K32-212F-I-4-BB2-M304-A	4"	100mm	32 to 212°F
N1-T1K32-212F-I-8-BB2-M304-A	8"	200mm	32 to 212°F

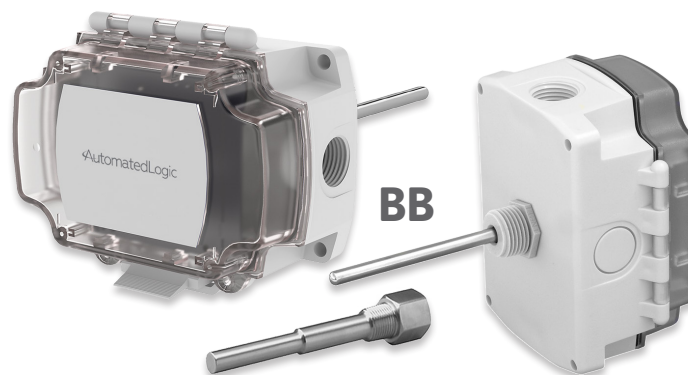

**BB**

Polycarbonate BB (IP66, NEMA 4X)

Part Number:	Probe Length:		Temp. Range:
N1-T1K32-212F-I-8-BB-M304-A	8"	200mm	32 to 212°F



# Thermowells for Immersion Temperature Sensors

- 304 or 316 Stainless Steel or Brass Material
- 2", 4" and 8" (Fit Standard Immersion Sensor Lengths)



304 Stainless Steel

Part Number:	Probe Length:		Thermo.
N1-2-M304-A	2"	50mm	304 SS
N1-4-M304-A	4"	100mm	304 SS
N1-8-M304-A	8"	200mm	304 SS



316 Stainless Steel

Part Number:	Probe Length:		Thermo.
N1-2-M316-A	2"	50mm	316 SS
N1-4-M316-A	4"	100mm	316 SS
N1-8-M316-A	8"	200mm	316 SS



Brass

Part Number:	Probe Length:		Thermo.
N1-2-MB-A	2"	50mm	Brass
N1-4-MB-A	4"	100mm	Brass
N1-8-MB-A	8"	200mm	Brass

## Immersion Temperature Sensors with Stainless Steel Threads

- 10K-2 Thermistor Temperature Sensor
- Stainless Steel Probe, 1/4" (6.3mm) Diameter
- 3 Enclosure Styles  
(see pgs 42-43 for enclosure info)

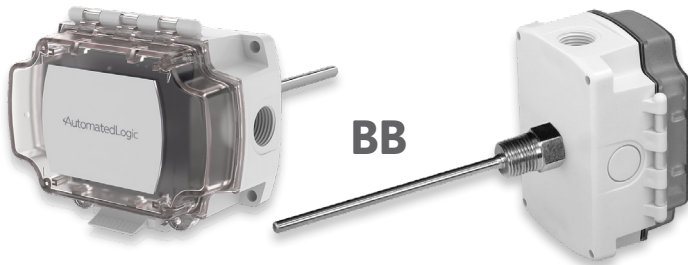

Polycarbonate BB (IP66, NEMA 4X)

Part Number:	Probe Length:	
N1-10K-2-I-2-SS-BB-A	2"	50mm

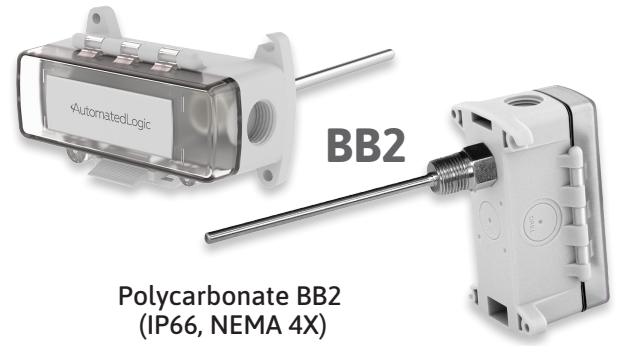

Polycarbonate BB2 (IP66, NEMA 4X)

Part Number:	Probe Length:	
N1-10K-2-I-2-SS-BB2-A	2"	50mm
N1-10K-2-I-4-SS-BB2-A	4"	100mm
N1-10K-2-I-8-SS-BB2-A	8"	200mm

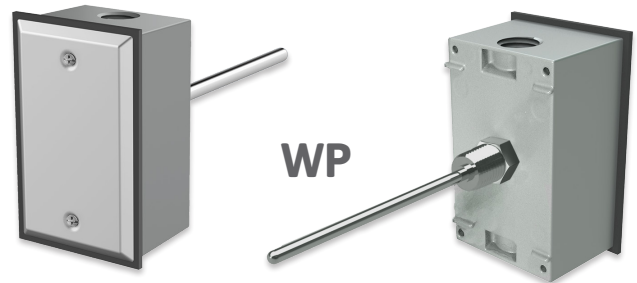

Cast Aluminum WP (IP24, NEMA 3R)

Part Number:	Probe Length:	
N1-10K-2-I-2-SS-WP-A	2"	50mm
N1-10K-2-I-4-SS-WP-A	4"	100mm

## Immersion Extra Precision Temperature Sensors with Stainless Steel Threads

- 10K-2 Extra Precision Thermistor
- Stainless Steel Probe, 1/4" (6.3mm) Diameter
- BB2 Enclosure Style (see pgs 42-43 for enclosure info)

Part Number:	Probe Length:	
N1-10K-2[XP]-I-2-SS-BB2-A	2"	50mm
N1-10K-2[XP]-I-4-SS-BB2-A	4"	100mm
N1-10K-2[XP]-I-8-SS-BB2-A	8"	200mm

Unit with Included 304 Stainless Steel Thermowell below

N1-10K-2[XP]-I-4-SS-BB2-M304-A	4"	100mm
--------------------------------	----	-------

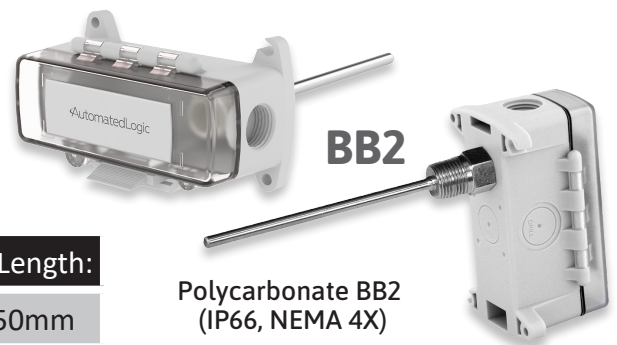

Polycarbonate BB2 (IP66, NEMA 4X)

# Remote Probe Temperature Sensors without Enclosure

- 10K-2 Thermistor Temperature Sensor
- Stainless Steel Bullet Probe 1.75" (44.5mm) Length, 1/4" (6.3mm) Diameter or Brass Concave Probe 1.35" (34.3mm) Length, 0.37" (9.3mm) Diameter
- Plenum-Rated, FEP-Jacketed or Submersible FEP-Jacketed Cable

Bullet Probe  
Plenum-Rated Cable

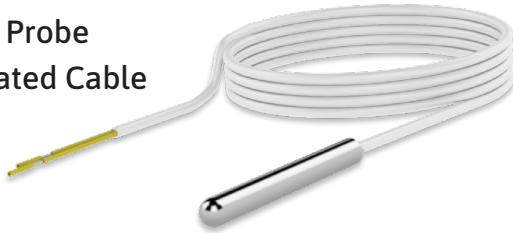

Part Number:	Cable Length:		Cable Type
NSB-10K-2-RPP-6-A	6"	150mm	Plenum-Rated
N1-10K-2-RPP-18-A	18"	450mm	Plenum-Rated
NSB-10K-2-RPP-5-A	5'	1.5m	Plenum-Rated
NSB-10K-2-RPP-10-A	10'	3m	Plenum-Rated
NSB-10K-2-RPP-15-A	15'	4.5m	Plenum-Rated
NSB-10K-2-RPP-25-A	25'	7.5m	Plenum-Rated
50K Thermistor instead of 10K-2 Thermistor below			
NSB-50K-RPP-5-A	5'	1.5m	Plenum-Rated

Bullet Probe  
FEP-Jacketed Cable

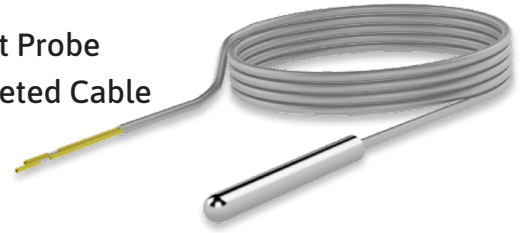

Part Number:	Cable Length:		Cable Type
NSB-10K-2-RPFEP-18-A	18"	450mm	FEP-Jacketed
NSB-10K-2-RPFEP-5-A	5'	1.5m	FEP-Jacketed
N1-10K-2-RPFEP-10-A	10'	3m	FEP-Jacketed
N1-10K-2-RPFEP-15-A	15'	4.5m	FEP-Jacketed
N1-10K-2-RPFEP-20-A	20'	6m	FEP-Jacketed
N1-10K-2-RPFEP-50-A	50'	15m	FEP-Jacketed
N1-10K-2-RPFEP-100-A	100'	30m	FEP-Jacketed

Bullet Probe  
Submersible FEP-Jacketed  
Cable

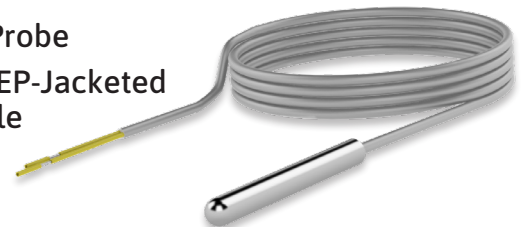

Concave Probe  
FEP-Jacketed Cable

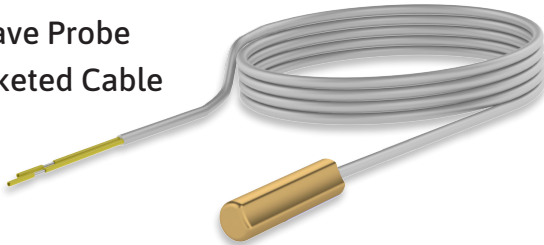

Part Number:	Cable Length:		Cable Type
N1-10K-2-CPFEP-5-A	5'	1.5m	FEP-Jacketed
N1-10K-2-CPFEP-10-A	10'	3m	FEP-Jacketed
N1-10K-2-CPFEP-25-A	25'	7.5m	FEP-Jacketed

Part Number:	Cable Length:		Cable Type
N1-10K-2-RPFEP2-18-A	18"	450mm	Submersible
NSB-10K-2-RPFEP2-5-A	5'	1.5m	Submersible
N1-10K-2-RPFEP2-10-A	10'	3m	Submersible
NSB-10K-2-RPFEP2-25-A	25'	7.5m	Submersible
N1-10K-2-RPFEP2-20-A	20'	6m	Submersible
N1-10K-2-RPFEP2-50-A	50'	15m	Submersible
N1-10K-2-RPFEP2-100-A	100'	30m	Submersible

50K Thermistor instead of 10K-2 Thermistor below

NSB-50K-RPFEP2-5-A	5'	1.5m	Submersible
--------------------	----	------	-------------



# Remote Probe Temperature Sensors with Enclosure

- 10K-2 Thermistor Temperature Sensor
- Stainless Steel Bullet Probe 1.75" (44.5mm) Length, 1/4" (6.3mm) Diameter or Brass Concave Probe 1.35" (34.3mm) Length, 0.37" (9.3mm) Diameter
- FEP-Jacketed Cable
- 4 Enclosure Styles (see pgs 42-43 for enclosure info)



## BB4

Polycarbonate & Nylon BB4 (IP10 or IP44 w/ knockout plug)

Bullet Probe

Part Number:	FEP Cable	
N1-10K-2-RPFEP-5-BB4-A	5'	1.5m
N1-10K-2-RPFEP-10-BB4-A	10'	3m



## BB

Polycarbonate BB (IP66, NEMA 4X)

Bullet Probe

Part Number:	FEP Cable	
N1-10K-2-RPFEP-18-BB-A	18"	450mm
N1-10K-2-RPFEP-10-BB-A	10'	3m
N1-10K-2-RPFEP-15-BB-A	15'	4.5m

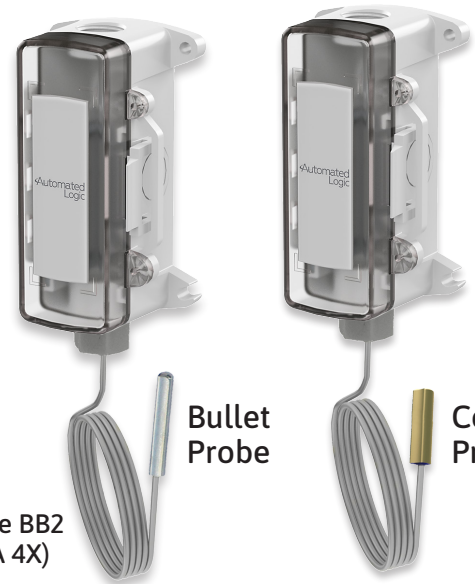

## BB2

Polycarbonate BB2 (IP66, NEMA 4X)

Bullet Probe

Concave Probe

Part Number:	FEP Cable		Probe
N1-10K-2-RPFEP-10-BB2-A	10'	3m	Bullet
N1-10K-2-CPFEP-5-BB2-A	5'	1.5m	Concave

Submersible FEP-Jacketed Cable below

N1-10K-2-RPFEP2-10-BB2-A	10'	3m	Bullet
--------------------------	-----	----	--------

Temperature Transmitter w/ Submersible FEP-Jacketed Cable below

N1-T1K20-120F-RPFEP2-25-BB2-A	25'	7.5m	Bullet
-------------------------------	-----	------	--------



## WP

Cast Aluminum WP (IP24, NEMA 3R)

Bullet Probe

Part Number:	FEP Cable	
N1-10K-2-RPFEP-18-WP-A	18"	450mm
N1-10K-2-RPFEP-5-WP-A	5'	1.5m

Halogen-Free Cable unit below

N1-10K-2-RPP-5-WP-HFW-A	5'	1.5m
-------------------------	----	------

# Strap and Clamp-on Temperature Sensors

- 10K-2 Thermistor Temperature Sensor
- Strap Units for Pipes from 5 to 14.5" (130 to 370mm) in Dia. with up to 2" (50mm) of Insulation
- Clamp-On Units for Pipes from 2 to 4.5" (50 to 114mm) in Dia.
- 3 Enclosure Styles (see pgs 42-43 for enclosure info)

## Strap BB4

Polycarbonate & Nylon BB4 (IP10 or IP44 w/ knockout plug)

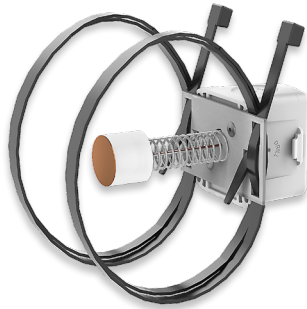

Part Number:	Type
NSB-10K-2-STP-BB4-A	Strap Sensor

## Strap BB2

Polycarbonate BB2 (IP66, NEMA 4X)

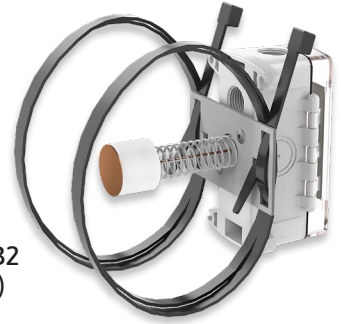

Part Number:	Type
NSB-10K-2-STP-BB2-A	Strap Sensor

## Strap JB

Galvanized Steel JB (IP20, NEMA 1)



Part Number:	Type
NSB-10K-2-STP-A	Strap Sensor

## Clamp BB2

Polycarbonate BB2 (IP66, NEMA 4X)

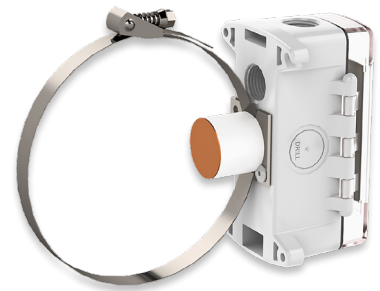

Part Number:	Type
NSB-10K-2-S-BB2-A	Clamp-On Sensor

## Clamp BB4

Polycarbonate & Nylon BB4 (IP10 or IP44 w/ knockout plug)

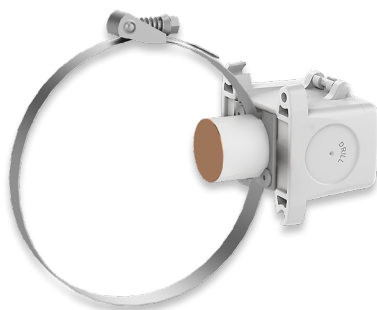

Part Number:	Type
NSB-10K-2-S-BB4-A	Clamp-On Sensor

## Clamp JB

Galvanized Steel JB (IP20, NEMA 1)



Part Number:	Type
NSB-10K-2-S-A	Clamp-On Sensor

50K Thermistor instead of 10K-2 Thermistor below

NSB-50K-S-A	Clamp-On Sensor
-------------	-----------------

# Thermobuffer Temperature Sensors for Freezers/Coolers

- 10K-2 Thermistor Temperature Sensor
- M304 Stainless Steel Buffer Chamber
- Attached Buffer Chamber or Hanging Bracket Buffer Chamber with FEP-Jacketed Cable
- 2 Enclosure Styles (see pgs 42-43 for enclosure info)



## BB2

Polycarbonate BB2  
(IP66, NEMA 4X)

Part Number:	Chamber	
NSB-10K-2-TB-M304-2-BB2-A	2"	50mm
N1-10K-2-TB-M304-4-BB2-A	4"	100mm



## BB

Polycarbonate BB  
(IP66, NEMA 4X)

Part Number:	Chamber	
N1-10K-2-TB-M304-2-BB-A	2"	50mm
N1-10K-2-TB-M304-4-BB-A	4"	100mm



## BB2

Polycarbonate BB2  
(IP66, NEMA 4X)

Part Number:	Chamber		Cable	
N1-10K-2-TB-M304-1-HB-BB2-A	1"	25mm	30"	760mm
N1-10K-2-TB-M304-1-HB-BB2-25-A	1"	25mm	25'	7.6m

Part Number:	Chamber		Cable	
N1-10K-2-TB-M304-1-HB-BB-A	1"	25mm	30"	760mm
N1-10K-2-TB-M304-2-HB-BB-25-A	2"	50mm	25'	7.6m



## NB

No Enclosure

Part Number:	Chamber		Cable	
NSB-10K-2-TB-M304-1-HB-NB-10-A	1"	25mm	10'	3m
N1-10K-2-TB-M304-1-HB-NB-25-A	1"	25mm	25'	7.6m



## BB

Polycarbonate BB  
(IP66, NEMA 4X)



## Submersible Duct Temperature Sensors

- 10K-2 Thermistor Temperature Sensor
- Stainless Steel, 1/8" diameter probe with 4" sleeve (1/4" diameter)
- BB Enclosure Style (see pgs 42-43 for enclosure info)

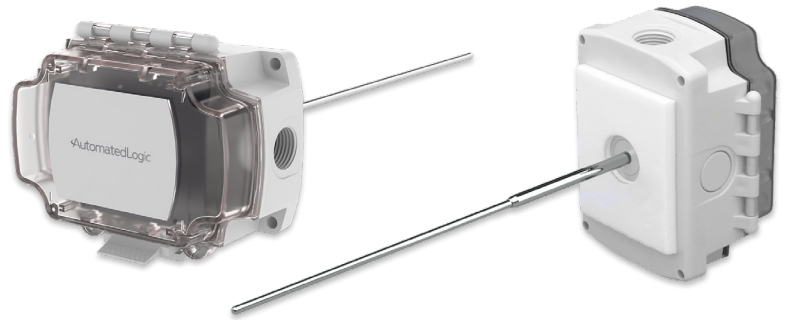

**BB** Polycarbonate BB (IP66, NEMA 4X)

Part Number:	Probe Length	
N1-10K-2-SD-12-BB-A	12"	300mm
N1-10K-2-SD-18-BB-A	18"	450mm

## Analog ZS2 Room Temperature Sensors

- 10K-2 or 50K Thermistor Temperature Sensor
- Optional ALC Logo



Part Number:	ALC Logo
NSB-ZS2-10K-2-A	With Logo
NSB-ZS2-10K-2-B	Without Logo
50K Thermistor instead of 10K-2	
NSB-ZS2-50K-A	With Logo

## Delta Style Room Temperature Sensors

- 10K-2 Thermistor Temperature Sensor
- Optional Foamback Insulator



Part Number:	Foamback Insulator
N1-10K-2-R-BW-A	Without Foamback
N1-10K-2-R-FOAM-BW-A	With Foamback

## Low Profile Temperature Sensors

- 10K-2 or 50K Thermistor Temperature Sensor
- Less than a Quarter in Size

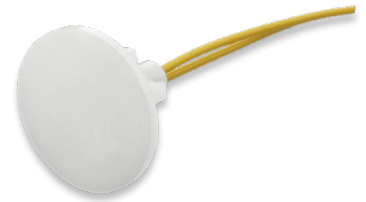

Part Number:
NSB-10K-2-LPW-A
50K Thermistor instead of 10K-2 below
NSB-50K-LPW-A

## Wall Plate Temperature Sensors

- 10K-2 Thermistor Temperature Sensor
- Aluminum or Stainless Steel Material
- Optional ALC Logo
- Optional Override Button



Part Number:	Material	ALC Logo	Override
N1-10K-2-AP-A	Aluminum	With Logo	No Override
NSB-10K-2-SP-A	Stainless Steel	With Logo	No Override
NSB-10K-2-SP-BNK-A	Stainless Steel	Without Logo	No Override
N1-10K-2-SP-O2-A	Stainless Steel	With Logo	Override Button
Temperature Transmitter unit below			
N1-T1K[20 TO 120F]-SP-A	Stainless Steel	With Logo	No Override

## **Humidity or Temperature/Humidity Sensors**



# Humidity or Temperature/Humidity Sensors



Duct Sensors  
pg. 26

---



Outside Air  
Sensors  
pg. 27

---



Delta Style  
Sensors  
pg. 28

# Duct Humidity or Temp/Humidity Sensors

- Optional 10K-2 Thermistor Temperature Sensor
- $\pm 2\%$  or  $\pm 3\%$  RH Accuracy
- 0 to 5 or 0 to 10V %RH Output
- 3 Enclosure Styles (see pgs 42-43 for enclosure info)



**BB2** Polycarbonate BB2  
(IP66, NEMA 4X)

Part Number:	Temperature	%RH Accuracy	%RH Output
N1-H200-D-BB2-A	None	$\pm 2\%$ RH	0 to 5V
N1-H300-D-BB2-A	None	$\pm 3\%$ RH	0 to 5V
NSB-10K-2-H200-D-BB2-A	10K-2 Therm.	$\pm 2\%$ RH	0 to 5V
N1-10K-2-H210-D-BB2-A	10K-2 Therm.	$\pm 2\%$ RH	0 to 10V
N1-10K-2-H300-D-BB2-A	10K-2 Therm.	$\pm 3\%$ RH	0 to 5V
N1-10K-2-H310-D-BB2-A	10K-2 Therm.	$\pm 3\%$ RH	0 to 10V



**BB** Polycarbonate BB  
(IP66, NEMA 4X)

Part Number:	Temperature	%RH Accuracy	%RH Output
N1-H200-D-BB-A	None	$\pm 2\%$ RH	0 to 5V
N1-H300-D-BB-A	None	$\pm 3\%$ RH	0 to 5V
N1-10K-2-H200-D-BB-A	10K-2 Therm.	$\pm 2\%$ RH	0 to 5V
N1-10K-2-H210-D-BB-A	10K-2 Therm.	$\pm 2\%$ RH	0 to 10V
N1-10K-2-H300-D-BB-A	10K-2 Therm.	$\pm 3\%$ RH	0 to 5V



**WP** Cast Aluminum WP  
(IP24, NEMA 3R)

Part Number:	Temperature	%RH Accuracy	%RH Output
N1-H200-D-WP-A	None	$\pm 2\%$ RH	0 to 5V
N1-H300-D-WP-A	None	$\pm 3\%$ RH	0 to 5V
N1-10K-2-H200-D-WP-A	10K-2 Therm.	$\pm 2\%$ RH	0 to 5V
N1-10K-2-H210-D-WP-A	10K-2 Therm.	$\pm 2\%$ RH	0 to 10V
N1-10K-2-H300-D-WP-A	10K-2 Therm.	$\pm 3\%$ RH	0 to 5V

# Outside Air Humidity or Temp/Humidity Sensors

- Optional 10K-2 Thermistor Temperature Sensor
- $\pm 2\%$  or  $\pm 3\%$ RH Accuracy
- 0 to 5V %RH Output
- 3 Enclosure Styles (see pgs 42-43 for enclosure info)



**BB2**  
Polycarbonate BB2  
(IP66, NEMA 4X)

Part Number:	Temperature	%RH Accuracy	%RH Output
N1-H200-O-BB2-A	None	$\pm 2\%$ RH	0 to 5V
NSB-10K-2-H200-O-BB2-A	10K-2 Therm.	$\pm 2\%$ RH	0 to 5V
N1-10K-2-H300-O-BB2-A	10K-2 Therm.	$\pm 3\%$ RH	0 to 5V



**BB**  
Polycarbonate BB  
(IP66, NEMA 4X)

Part Number:	Temperature	%RH Accuracy	%RH Output
N1-10K-2-H200-O-BB-A	10K-2 Therm.	$\pm 2\%$ RH	0 to 5V
N1-10K-2-H300-O-BB-A	10K-2 Therm.	$\pm 3\%$ RH	0 to 5V



**WP**  
Cast Aluminum WP  
(IP24, NEMA 3R)

Part Number:	Temperature	%RH Accuracy	%RH Output
N1-H200-O-WP-A	None	$\pm 2\%$ RH	0 to 5V
N1-10K-2-H200-O-WP-A	10K-2 Therm.	$\pm 2\%$ RH	0 to 5V
N1-10K-2-H300-O-WP-A	10K-2 Therm.	$\pm 3\%$ RH	0 to 5V

## Delta Style Room Humidity or Temp/Humidity Sensors without Display

- Optional 10K-2 Thermistor Temperature Sensor
- $\pm 2\%$  or  $\pm 3\%$  RH Accuracy
- 0 to 5V %RH Output
- Optional Display



Part Number:	Temperature	%RH Accuracy	%RH Output
N1-H200-R-BW-A	None	$\pm 2\%$ RH	0 to 5V
N1-H300-R-BW-A	None	$\pm 3\%$ RH	0 to 5V
N1-10K-2-H200-R-BW-A	10K-2 Therm.	$\pm 2\%$ RH	0 to 5V
N1-10K-2-H300-R-BW-A	10K-2 Therm.	$\pm 3\%$ RH	0 to 5V



## Delta Style Room Humidity Sensor with Display

- Optional 10K-2 Thermistor Temperature Sensor
- $\pm 2\%$  or  $\pm 3\%$  RH Accuracy
- 0 to 5V %RH Output
- Optional Display



Part Number:	Temperature	%RH Accuracy	%RH Output
N1-H200-RD-BW-A	None	$\pm 2\%$ RH	0 to 5V

## **Differential Air Pressure Sensors, Switches, and Accessories**

# Differential Air Pressure Sensors, Switches, and Accessories



ZPM BB (IP66) Sensor  
pg. 32



ZPM (IP44) Sensor  
pg. 32



EZ Panel Mount Sensor  
pg. 32



Pressure Switch BB  
pg. 33



Beck Pressure Switch  
pg. 33



Pressure Pickup Ports  
pg. 34



Pressure Probes  
pg. 34

# Differential Air Pressure Sensors

- 6" (150mm) Static Tube Included on ZPM BB and ZPM, Optional on EZ
- Field Selectable Outputs and Ranges
- Standard, Low and High Pressure Ranges



## ZPM BB

Polycarbonate BB  
(IP66, NEMA 4X)

Part Number:	Pressure Range
N1-ZPM-SR-ST-D-BB-A	Standard Ranges: -5 to +5" W.C. (-1,250 to +1,250 Pa)
N1-ZPM-LR-ST-D-BB-A	Low Ranges: -1 to +1" W.C. (-250 to +250 Pa)
N1-ZPM-HR-ST-D-BB-A	High Ranges: 0 to +30" W.C. (0 to +7,400 Pa)



## ZPM

Polycarbonate ZPM  
(IP44)

Part Number:	Pressure Range
NSB-ZPM-SR-ST-D-A	Standard Ranges: -5 to +5" W.C. (-1,250 to +1,250 Pa)
NSB-ZPM-LR-ST-D-A	Low Ranges: -1 to +1" W.C. (-250 to +250 Pa)
NSB-ZPM-HR-ST-D-A	High Ranges: 0 to +30" W.C. (0 to +7,400 Pa)



**EZ**  
Panel Mount  
EZ

Part Number:	Pressure Range	Static Tube
NSB-ZPS-SR-EZ-ST-IN-A	Standard W.C.: -5 to +5" W.C.	Included 6" (150mm)
NSB-ZPS-SR-EZ-ST-PA-A	Standard Pa: -1,250 to +1,250 Pa	Included 6" (150mm)
NSB-ZPS-LR-EZ-ST-IN-A	Low W.C.: -1 to +1" W.C.	Included 6" (150mm)
NSB-ZPS-LR-EZ-ST-PA-A	Low Pa: -250 to +250 Pa	Included 6" (150mm)
N1-ZPS-SR-EZ-NT-IN-A	Standard W.C.: -5 to +5" W.C.	No Tube
N1-ZPS-SR-EZ-NT-PA-A	Standard Pa: -1,250 to +1,250 Pa	No Tube
N1-ZPS-LR-EZ-NT-IN-A	Low W.C.: -1 to +1" W.C.	No Tube
N1-ZPS-LR-EZ-NT-PA-A	Low Pa: -250 to +250 Pa	No Tube



# Differential Air Pressure Switches

- Field Adjustable Setpoint
- BB Unit with Field Adjustable Setpoint from 0.1" to 40" W.C. (20 to 10,000 Pa)
- Beck Adjustable Unit (IP65 or IP54 Rated)



## BB Polycarbonate BB Enclosure

Part Number:	Pressure Range
N1-ZPS-SW1-A	0.1" to 0.8" W.C. (20 to 200 Pa) Factory Setting
NSB-ZPS-SW2-A	0.5" to 1.2" W.C. (120 to 300 Pa) Factory Setting
NSB-ZPS-SW3-A	0.7" to 2.2" W.C. (180 to 550 Pa) Factory Setting



## BECK (IP66 or IP54)

Part Number:	Pressure Range	Enclosure Rating
N1-APSW1-65-A	0.08 to 1.2" W.C. (20 to 300 Pa)	IP65
N1-APSW2-65-A	0.2 to 2" W.C. (50 to 500 Pa)	IP65
N1-APSW3-65-A	0.8 to 4" W.C. (200 to 1,000 Pa)	IP65
N1-APSW1-A	0.08 to 1.2" W.C. (20 to 300 Pa)	IP54
N1-APSW2-A	0.2 to 2" W.C. (50 to 500 Pa)	IP54
N1-APSW3-A	0.8 to 4" W.C. (200 to 1,000 Pa)	IP54

# Differential Air Pressure Pickup Ports

- ZS Room Enclosure, Wall and Ceiling Plates, Outside Air and Low Profile Models
- Automated Logic Logo on ZS2 and Wall Plates



## ZS2

ZS Room Enclosure

Part Number:

NSB-RSPPP-A



## Wall Plate

Stainless Steel Wall Plate with Optional 10K-2 Thermistor

Part Number:

NSB-ZPS-ACC01-A

N1-ZPS-ACC01-102-A

Temperature

None

10K-2 Therm.

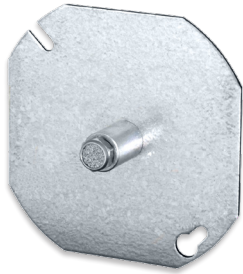

## Ceiling

Galvanized Steel for Ceiling Tiles

Part Number:

NSB-ZPS-ACC05-A



## Low Profile

ABS Plastic Unit

Part Number:

NSB-ZPS-ACC20-A



Horizontal Mount

Vertical Mount

## Outside Air

Part Number:

NSB-ZPS-ACC10-A

N1-ZPS-ACC10-V-A

Mounting

Horizontal

Vertical

# Differential Air Pressure Probes

- Aluminum Static and Total Probes and Probe Assemblies
- Assemblies include Foam Pad, Rubber Tubing with Surge Damper, Sheet Metal Screws and Bulkhead Fitting



**Static Probe Assembly**

Part Number:	Probe Length	
NSB-ZPS-ACC07-A	6"	150mm



**Two Static Probe Assemblies**

Part Number:	Probe Length	
N1-ZPS-ACC18-A	6"	150mm



**Pitot Probe Assembly**

Part Number:	Probe Length	
NSB-ZPS-ACC11-A	3.5"	90mm
N1-ZPS-ACC12-A	6"	150mm



**Static Probe & Foam Pad**

Part Number:	Probe Length	
NSB-ZPS-ACC08-A	6"	150mm



**Total Probe & Foam Pad**

Part Number:	Probe Length	
N1-ZPS-ACC13-A	3.5"	90mm
N1-ZPS-ACC14-A	6"	150mm



**Surge Damper, 5 micron**

Part Number:
N1-ZPS-ACC15-A

## **Air Quality Sensors**



# Air Quality Sensors



**Carbon Dioxide (CO<sub>2</sub>)  
Room Sensors**  
pg. 38



**Carbon Dioxide (CO<sub>2</sub>)  
Duct Sensors**  
pg. 38



**Volatile Organic  
Compound (VOC) Duct  
Sensors**  
pg. 39



**Programmable Carbon  
Monoxide (CO) Duct and  
Rough Service**  
pg. 40



**Carbon Monoxide (CO)  
Rough Service**  
pg. 40



**Nitrogen Dioxide (NO<sub>2</sub>)  
Duct and Rough Service**  
pg. 41



**Particulate Matter Room  
and Duct Sensors**  
pg. 42



**Refrigerant Leak  
Detectors**  
pg. 43

# Carbon Dioxide (CO<sub>2</sub>) Sensors

- Dual Channel for Continuously Occupied Areas
- BS Quantum Room Sensor or Duct BB Sensor



## BS Quantum Room Unit

Part Number:	PPM Range	Output	LEDs
N1-AQX-C-A	0 to 2,000	0 to 5V	3 LEDs
N1-AQX-D-A	0 to 2,000	0 to 10V	3 LEDs
N1-AQX-E-A	0 to 5,000	0 to 5V	No LEDs
N1-AQX-F-A	0 to 5,000	0 to 10V	No LEDs



## BB Duct Unit

Polycarbonate BB  
(IP66, NEMA 4X)

Part Number:	PPM Range	Output	LEDs
NSB-DCD05-D-BB-LED-A	0 to 2,000	0 to 5V	3 LEDs
N1-DCD10-D-BB-LED-A	0 to 2,000	0 to 10V	3 LEDs
N1-DCD05-5K-D-BB-A	0 to 5,000	0 to 5V	No LEDs
N1-DCD10-5K-D-BB-A	0 to 5,000	0 to 10V	No LEDs

# Volatile Organic Compound (VOC) Sensors

- CO<sub>2</sub> Equivalent Output (0 To 2,000 ppm) or Total VOC Output (0 to 2,500 ppb)
- Duct BB Sensor



## CO<sub>2</sub> Equivalent VOC Duct Unit

Polycarbonate BB  
(IP66, NEMA 4X)

Part Number:	Measurement	Range	Output
N1-VOC05-D-BB-A	CO <sub>2</sub> Equivalent	0 to 2,000 ppm	0 to 5V
N1-VOC10-D-BB-A	CO <sub>2</sub> Equivalent	0 to 2,000 ppm	0 to 10V



## Total VOC Duct Unit

Polycarbonate BB  
(IP66, NEMA 4X)

Part Number:	Measurement	Range	Output
N1-TVOC05-D-BB-A	Total VOC	0 to 2,500 ppb	0 to 5V
N1-TVOC10-D-BB-A	Total VOC	0 to 2,500 ppb	0 to 10V

## Programmable Carbon Monoxide (CO) Sensors

- 4 Field Selectable CO Ranges: 0 to 100, 0 to 200, 0 to 300 and 0 to 500 PPM
- Field Selectable Output of 4 to 20 mA, 0 to 5, 1 to 5, 0 to 10 or 2 to 10V



### Duct BB Unit

Polycarbonate BB (IP66, NEMA 4X)

Part Number:

NSB-CO-D-BB-A

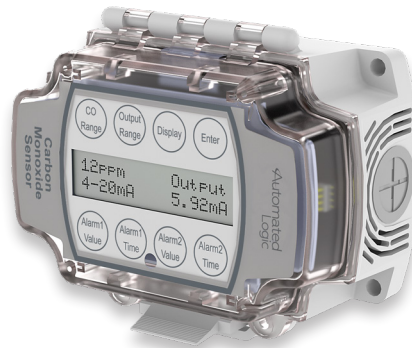

### Rough Service BB Unit

Ventilated Polycarbonate BB

Part Number:

NSB-CO-V-BB-A

## Carbon Monoxide (CO) Replacement Module for Programmable Units

- Approximate 7 Year Life Span
- For All Programmable NSB CO Sensors

Part Number:

NSB-COS-A



## Carbon Monoxide (CO) Rough Service Sensor

- 0 to 500 PPM CO Range
- Field Selectable CO Output of 0 to 5, 1 to 5, 0 to 10 or 2 to 10V



Ventilated Polycarbonate BB

### CO Only Rough Service BB Unit

Part Number:	Measurement	Output
NSB-BBV-CO-A	CO Only	Voltage



## Programmable Nitrogen Dioxide (NO<sub>2</sub>) Sensors

- 4 Field Selectable NO<sub>2</sub> Ranges: 0 to 2.5, 0 to 5, 0 to 7.5 and 0 to 10 PPM
- Field Selectable Output of 4 to 20 mA, 0 to 5, 1 to 5, 0 to 10 or 2 to 10V



### Duct Unit

Polycarbonate BB  
(IP66, NEMA 4X)

Part Number:

NSB-NO2-D-BB-A

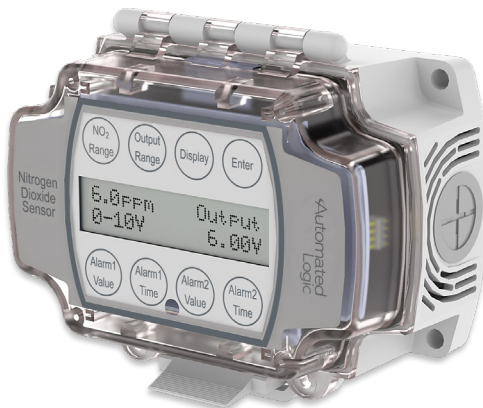

### Rough Service Unit

Ventilated  
Polycarbonate BB

Part Number:

NSB-NO2-V-BB-A

## Nitrogen Dioxide (NO<sub>2</sub>) Replacement Module

- Approximate 7 Year Life Span
- For All NSB NO<sub>2</sub> Sensors

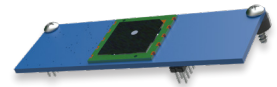

Part Number:

NSB-NO2S-A

# Particulate Matter Sensors

- Field Selectable Particulate Size of PM1.0, PM2.5 and PM10
- Field Selectable Outputs of 0 to 5V, 0 to 10V and 4 to 20mA



Polycarbonate BB  
(IP66, NEMA 4X)

## Duct Unit

Part Number:

N1-PM-D-BB-A



## ZS2 Room Sensor

Part Number:

N1-ZS2-PM-A

## Refrigerant Leak Detector

- 0 to 5VDC Output
- Detects Most Modern Refrigerants

Polycarbonate BB  
(IP66, NEMA 4X)



Part Number:

NSB-RLD-A

---

## Refrigerant Leak Detector Replacement Sensor

- For NSB Refrigerant Leak Detectors



Part Number:

N1-RLD-EL-A

## Accessories for HVAC/R

# Accessories for HVAC/R



Water Leak Detectors  
pg. 46



Voltage Converters (350mA)  
pg. 47



Thermostat Guards  
pg. 47

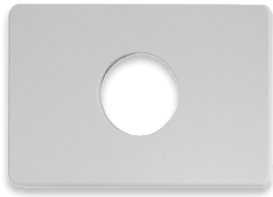

Adaptor Plates for Retrofits  
pg. 48

Foamback Insulator for Room Units  
pg. 49



Flexible Probe Brackets  
pg. 49



Pierceable Knockout Plugs  
pg. 49

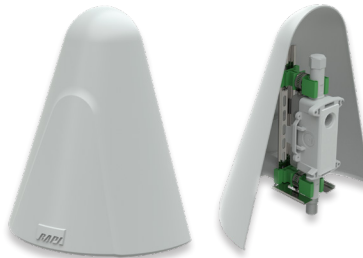

Weather Shade Kit - pg. 50

Light Level Sensors  
pg. 50



Output Terminal Boards  
pg. 51

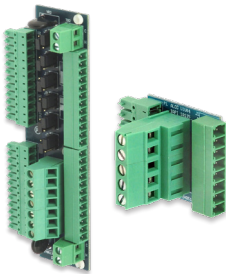

Output Relay Board  
pg. 51

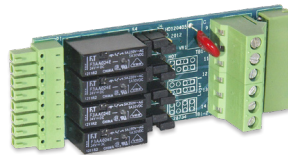

Relay Pack for the ZN551 Controller  
pg. 51

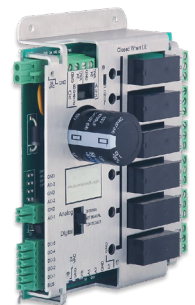

Blü-Test Wireless Test Instruments  
pg. 52



Calibration Certificates for Temperature and Humidity  
pg. 53

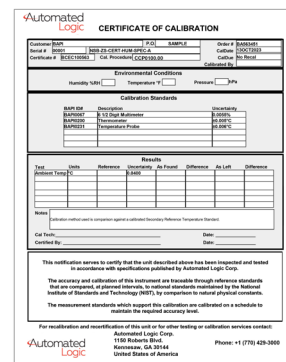



# Water Leak Detectors

- Built-In Sensor, Remote Sensor or Remote Rope Sensor
- Two 5A SPDT Relay Contacts
- Polycarbonate BAPI-Box Enclosure (IP66, NEMA 4X)

Part Number:

NSB-LDT4-PS-BB-A

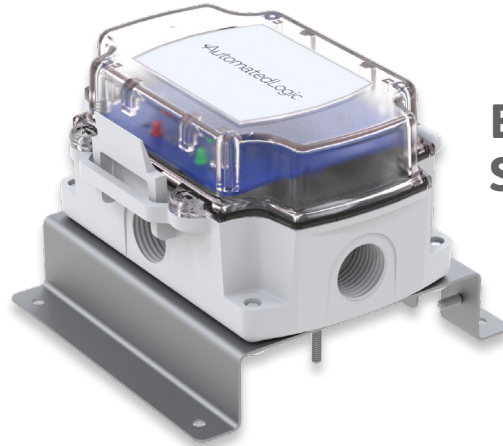

**Built-In Sensor**

Part Number:

FEP-Jacketed Cable Length

N1-LDT4-RS5-BB-A	5'	1.5m
------------------	----	------

NSB-LDT4-RS10-BB-A	10'	3m
--------------------	-----	----

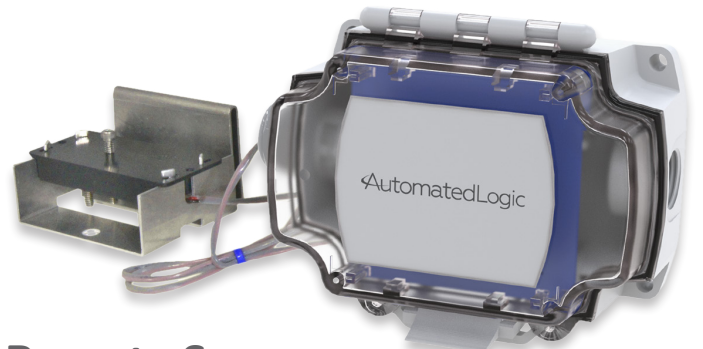

**Remote Sensor**

Part Number:

Rope Detector Cable Length

NSB-LDT4-RR10-BB-A	10'	3m
--------------------	-----	----

NSB-LDT4-RR25-BB-A	25'	7.5m
--------------------	-----	------

NSB-LDT4-RR50-BB-A	50'	15m
--------------------	-----	-----

NSB-LDT4-RR100-BB-A	100'	30m
---------------------	------	-----



**Rope Sensor**

## Voltage Converters (350mA)

- Ruggedized Circuit Snaptrack Mountable Unit (VC350A)  
or DIN Rail, Snaptrack or Surface Mountable Unit (VC350A-EZ)

Part Number:	Voltage Output
N1-VC350A-EZ-5-A	5 VDC Fixed Output
N1-VC350A-EZ-12-A	12 VDC Fixed Output
NSB-VC350A-EZ-ADJ-A	5 to 24 VDC Adjustable Output



**VC350A-EZ**  
DIN Rail, Snaptrack or Surface Mount

Part Number:	Voltage Output	Optional Snaptrack
N1-VC350A-ADJ-A	5 to 24 VDC Adjustable Output	No Snaptrack
N1-VC350A-ADJ-TRK-A	5 to 24 VDC Adjustable Output	1.25" (32mm) length

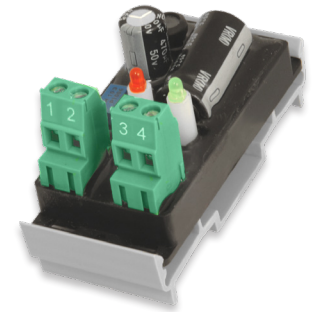

**VC350A**  
Shown with optional snaptrack

## Thermostat Guard

- Prevents Tampering, Damage and Unauthorized Adjustment
- Exceptional Airflow
- Made from Thick, Durable Polycarbonate

Part Number:	Internal Size	
NSB-BG2-A	3.55 x 3.5"	90.2 x 88.9mm
N1-BG-A	4.65 x 6.89"	118 x 175mm



# Adaptor Plates for Retrofits

- ABS Flame-Retardant Plastic
- Covers Wall Imperfections When Replacing Wall Sensors or Thermostats
- Bright White, Off White Color or Warm White Color

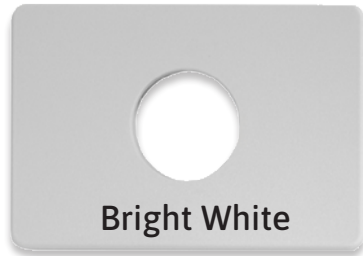

Part Number:	Outside Dimensions		Color
NSB-ADP-37-55-BW-A	3.75 x 5.5"	95.3 x 140mm	Bright White
NSB-ADP-37-55-OFW-A	4.65 x 6.89"	118 x 175mm	Off White



Part Number:	Outside Dimensions		Color
NSB-ADP-525-7-BW-A	5.25 x 7"	133.5 x 178mm	Bright White
NSB-ADP-525-7-OFW-A	5.25 x 7"	133.5 x 178mm	Off White



Part Number:	Outside Dimensions		Color
NSB-ADP-53-53-BW-A	5.3 x 5.3"	134.5 x 134.5mm	Bright White
NSB-ADP-53-53-OFW-A	5.3 x 5.3"	134.5 x 134.5mm	Off White
N1-ADP-53-53-WMW-A	5.3 x 5.3"	134.5 x 134.5mm	Warm White

## Flexible Probe Bracket for Averaging Sensors

- For Quick and Easy Mounting of Averaging Probes
- Scored Break-off for 1/4" (6.3mm) Rigid Probe Mounting
- Sold in Pack of 50

Part Number:	Amount
NSB-PB-50-A	Pack of 50



## Pierceable Knockout Plug for Enclosure Ports

- Pierceable Center Membrane
- Works in Non-Threaded Ports of the BB4 and JB Enclosure
- Sold in Pack of 100

Part Number:	Amount
NSB-PKP-100-A	Pack of 100



## Foamback Insulators

- 0.125" (3.2mm) and 0.25" (6.3mm) Thickness
- Measures 2.6" Wide by 4.4" High
- Packs of 100 Units

Part Number:	Thickness	
NSB-FB-.125-A	0.125"	3.2mm
NSB-FB-.250-A	0.25"	6.3mm



## Weather Shade Kit for Outdoor Sensors

- Improves Accuracy of Outside Air Sensors by Reducing Solar Heat Gain
- Simple and Sturdy Mounting Method
- UV-stabilized Polycarbonate

Part Number:  
N1-WSK-A

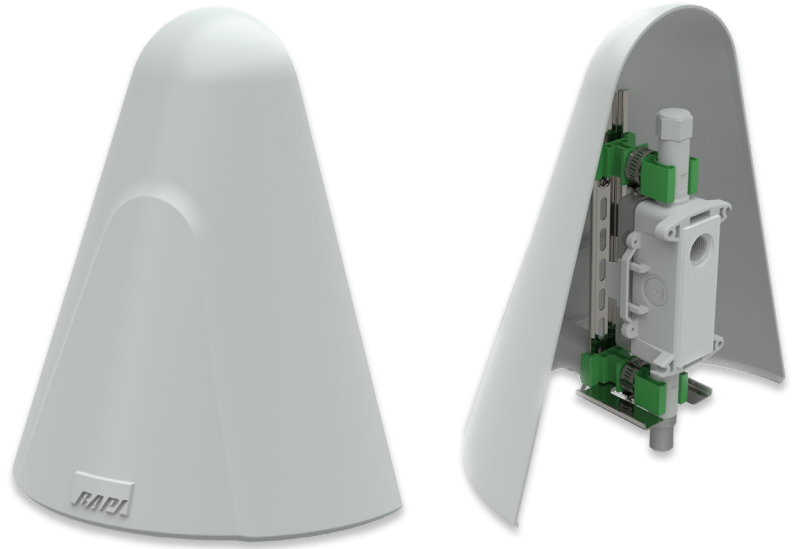

---

## Light Level Sensor

- Rugged and Watertight Enclosure
- Extremely Sensitive, Even in Dim Lighting
- 0 to 5V Output, 0 to 875 Foot Candle Range

Part Number:	Foot Candle Range	Output
N1-LLV-05-FC-A	0 to 875	0 to 5V





## Output Terminal Boards

- OUT64A - Provides Field Wiring Terminations for the SE6104A Controller Outputs
- OUT66 - Provides Field Wiring Terminations for the SE6166 Controller Outputs
- UIUO4 - Provides Field Wiring Terminations for ME812U, MEX816U, MEX88U, MEX016U, ME812U-LGR Controllers or Expander Modules

**OUT64A**

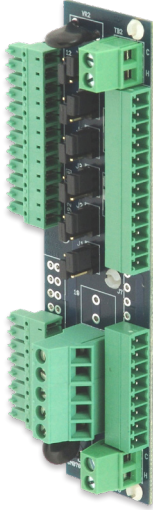

Part Number:

NSB-OUT64A

**OUT66**



Part Number:

NSB-OUT66

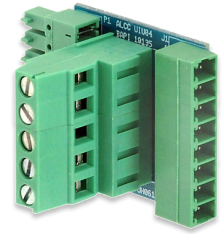

**UIUO4**

Part Number:

NSB-UIUO4

## Output Relay Boards

- UO4R - Plugs into the Outputs on the ME(X) Line of Controllers or Expanders, Can Provide 24 VAC/VDC Output to Power Relays, a Dry Contact Output or a Standard Universal Output
- ZN551 - Adds High Voltage/High Current Switching for a ZN Controller with 5 Relay Outputs and a Selectable Sixth Output

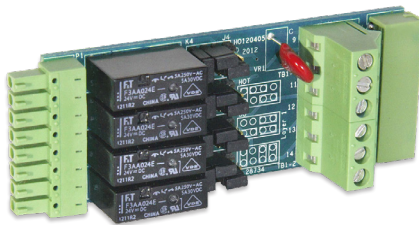

**UO4R**

Part Number:

NSB-UO4R

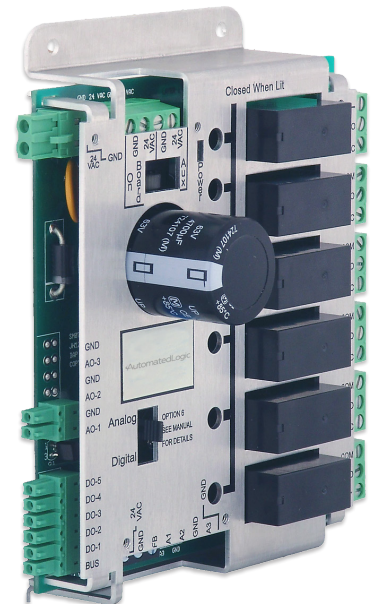

**ZN551**

Part Number:

NSB-RP-ZN551

# Blü-Test Wireless Test Instrument Bundle

- NIST-Traceable Test Instruments for Temperature, Relative Humidity and Differential Pressure
- Data Logging and Bluetooth Communication with Android and iOS Smart devices
- Bundle Includes 6 Units listed below plus a Carrying Case
  - 4" Piercing Temperature Unit, 1/8" diameter probe (100 x 3.2mm)
  - 6" Temperature Unit, 1/4" diameter probe (150 x 6.4mm)
  - 9.5" Temperature Unit, 1/4" diameter probe (240 x 6.4mm)
  - 8" Temp/Humidity Unit, 3/8" diameter (200 x 9.5mm)
  - Low Range Pressure Unit, -1 to +1" WC (-250 to +250 Pa)
  - Standard Range Pressure Unit, -5 to +5" WC (-1,250 to +1,250 Pa)

Part Number:

N1-BT-HVAC-BUNDLE

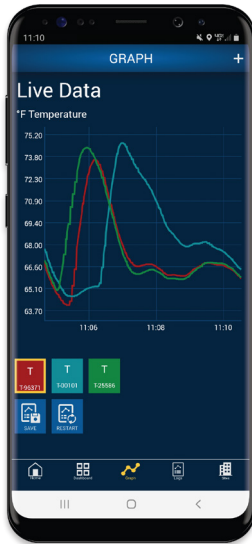

Smart Device App



Included Carrying Case



Blü-Test Wireless Test Instruments

# NIST-Traceable Certificates of Calibration

- One point ambient temperature or humidity, or three customer supplied temperature or humidity points

**Automated Logic** CERTIFICATE OF CALIBRATION

Customer: BAPI	P.O.:	SAMPLE	Order #	BA563451
Serial # 00001	NSB-ZS-CERT-HUM-SPECA		CalDate	13OCT2023
Certificate # BCEC100563	Cal. Procedure	CCP0100.00	CalDue	No Recal

Calibrated By: \_\_\_\_\_

---

**Environmental Conditions**

Humidity %RH     Temperature °F     Pressure  hPa

---

**Calibration Standards**

BAPI ID#	Description	Uncertainty
BAPI0067	6 1/2 Digit Multimeter	±0.0055%
BAPI0200	Thermometer	±0.005°C
BAPI0231	Temperature Probe	±0.006°C

---

**Results**

Test	Units	Reference	Uncertainty	As Found	Difference	As Left	Difference
Ambient Temp	°C		±0.0400				

Notes: Calibration method used is in comparison against a calibrated Secondary Reference Temperature Standard.

Cal Tech: \_\_\_\_\_ Date: \_\_\_\_\_  
 Certified By: \_\_\_\_\_ Date: \_\_\_\_\_

This notification serves to certify that the unit described above has been inspected and tested in accordance with specifications published by Automated Logic Corp.

The accuracy and calibration of this instrument are traceable through reference standards that are compared, at planned intervals, to national standards maintained by the National Institute of Standards and Technology (NIST), by comparison to natural physical constants.

The measurement standards which support this calibration are calibrated on a schedule to maintain the required accuracy level.

For recalibration and recertification of this unit or for other testing or calibration services contact:  
 Automated Logic Corp.  
 1150 Roberts Blvd.  
 Kennesaw, GA 30144  
 United States of America      Phone: +1 (770) 429-3000

<b>Part Number:</b>	<b>Certificate</b>
N1-ZS-CERT-TEMP-AMBIENT-A	NIST-Traceable Certification for Temperature at Ambient

<b>Part Number:</b>	<b>Certificate</b>
N1-ZS-CERT-TEMP-SPECA	NIST-Traceable Certification of Calibration for Temperature at one, two or three customer supplied temperature points.

<b>Part Number:</b>	<b>Certificate</b>
N1-ZS-CERT-HUM-AMBIENT-A	NIST-Traceable Certification for Humidity at Ambient

<b>Part Number:</b>	<b>Certificate</b>
N1-ZS-CERT-HUM-SPECA	NIST-Traceable Certification of Calibration for Humidity at one, two or three customer supplied humidity points at one temperature.

## Enclosures Overview

# Enclosures Overview

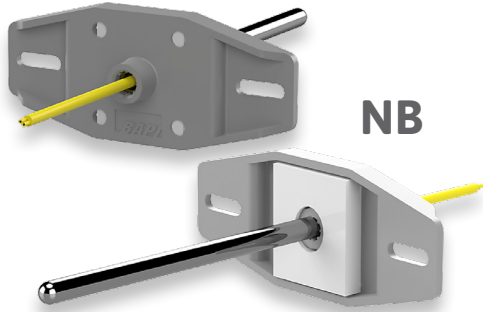

**NB**

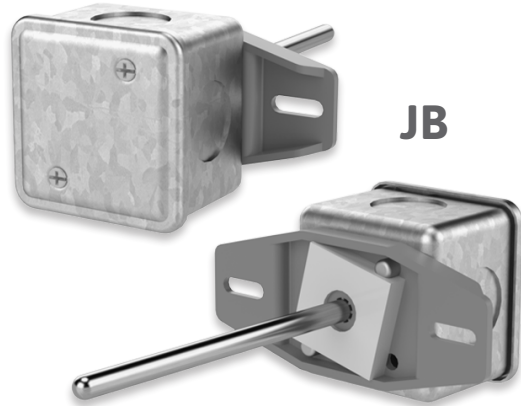

**JB**

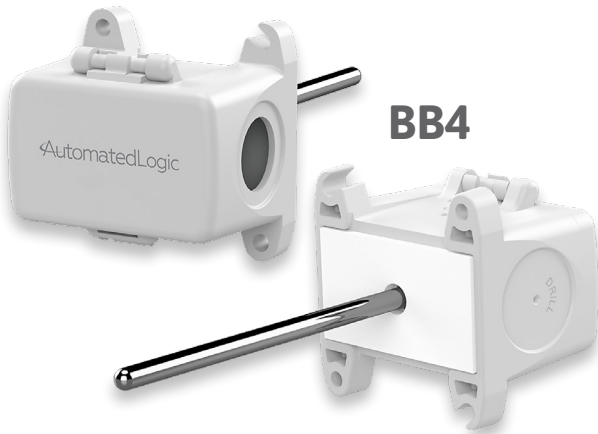

**BB4**

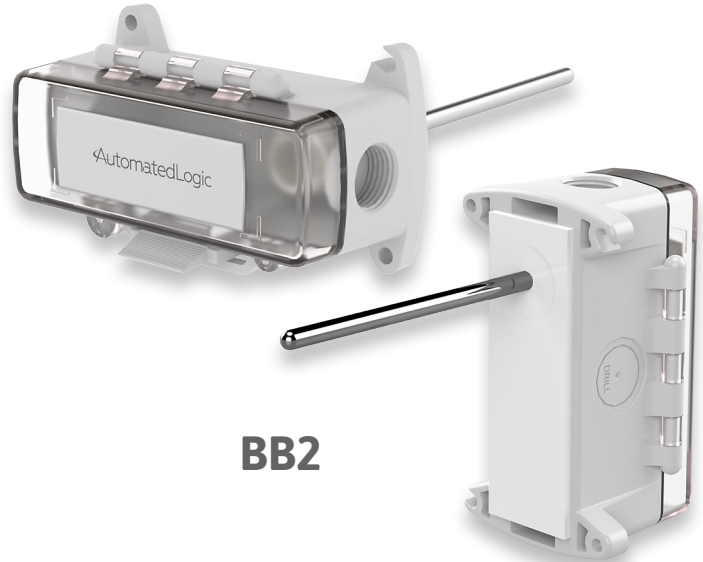

**BB2**

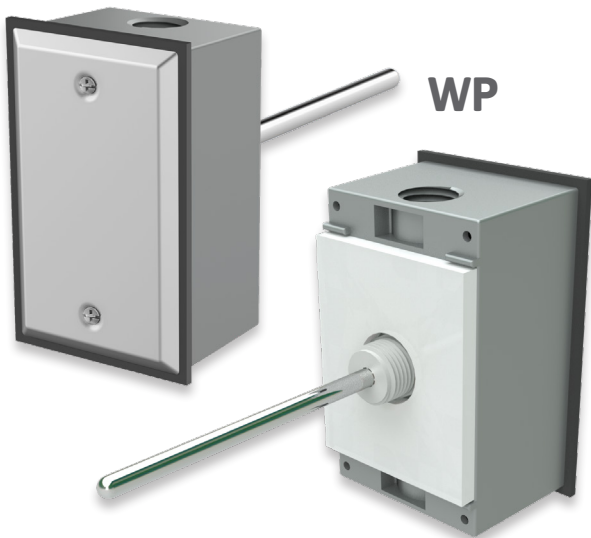

**WP**

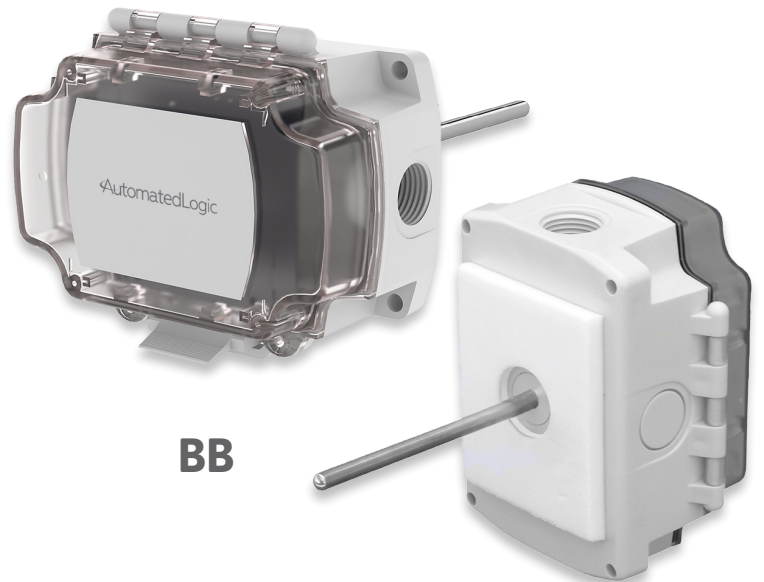

**BB**



# Enclosures Overview

There are six enclosure styles for non-room NSB sensors. These enclosure include the NB, JB, BB4, BB, BB2 and WP.

## INDOOR ENCLOSURES

### NB

The NB features a plastic mounting bracket with a foam gasket. It does not have an IP or NEMA rating.

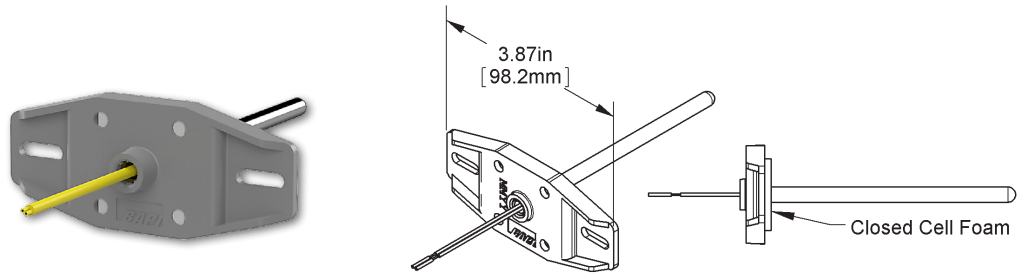

### JB

The Junction Box is made of galvanized steel with an IP20 and NEMA 1 rating. It includes a plastic mounting bracket and foam gasket.

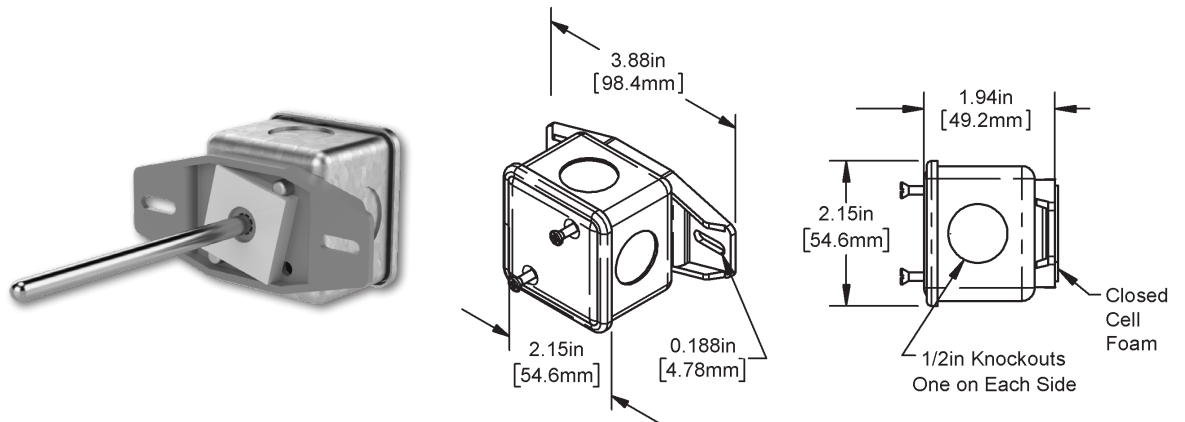

### BB4

The BB4 is made of nylon and polycarbonate and carries an IP10 rating (or an IP44 rating with the Pierceable Knockout Plug installed in the open port). It is half the size of the BB2 with a hinged (but not gasketed) cover.

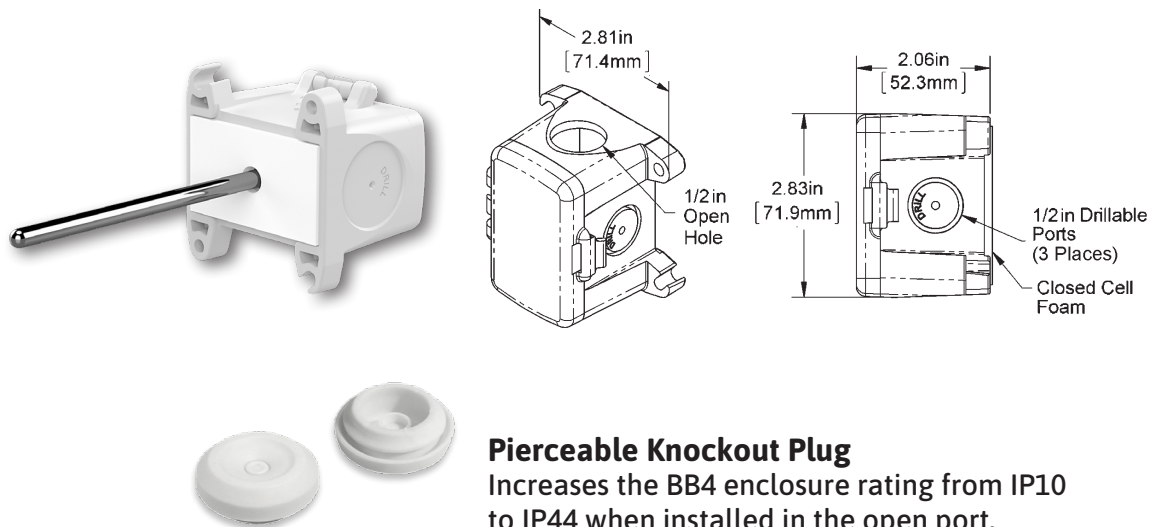

#### Pierceable Knockout Plug

Increases the BB4 enclosure rating from IP10 to IP44 when installed in the open port.

continued...

## INDOOR or OUTDOOR ENCLOSURES

### BB2

The BB2 is made of polycarbonate and carries an IP66 and NEMA 4X rating. It remains watertight even after multiple openings of the hinged cover.

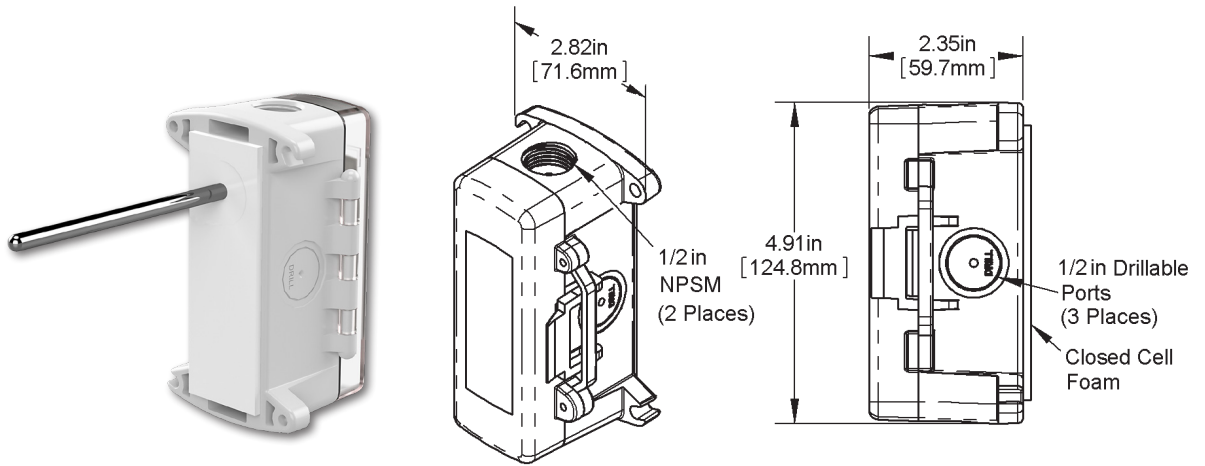

### BB

The BB is made of polycarbonate and carries an IP66 and NEMA 4X rating. It remains watertight even after multiple openings of the hinged cover.

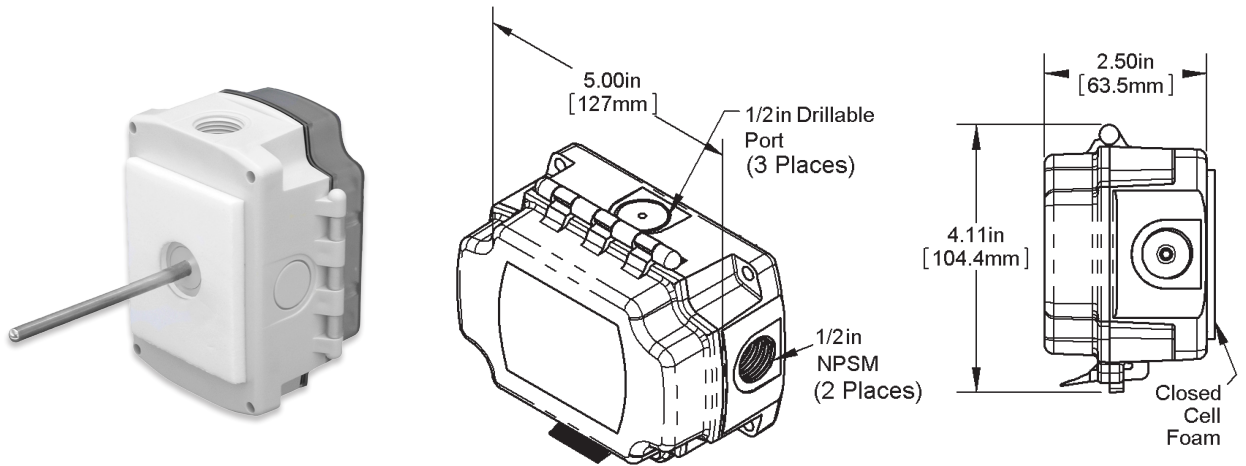

### WP

The WP is made of cast aluminum and carries a NEMA 3R and IP24 rating.

